

MAVIC 2 ENTERPRISE

Quick Start Guide

快速入门指南

快速入門指南

クイックスタートガイド

퀵 스타트 가이드

Kurzanleitung

Guía de inicio rápido

Guide de démarrage rapide

Guida di avvio rapido

Snelstartgids

Guia de início rápido

Guia de Início Rápido

Краткое руководство пользователя

v1.0

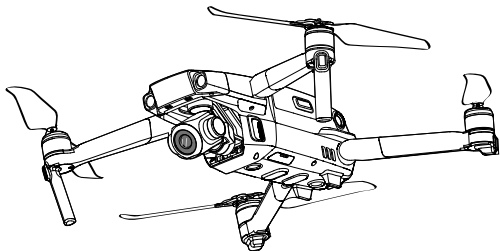

Contents

EN	Quick Start Guide	2
CHS	快速入门指南	12
CHT	快速入門指南	22
JP	クイックスタートガイド	32
KR	퀵 스타트 가이드	42
DE	Kurzanleitung	52
ES	Guía de inicio rápido	62
FR	Guide de démarrage rapide	72
IT	Guida di avvio rapido	82
NL	Snelstartgids	92
PT-PT	Guia de início rápido	102
PT-BR	Guia de Início Rápido	112
RU	Краткое руководство пользователя	122

Aircraft

The DJI™ MAVIC™ 2 Enterprise features omnidirectional Vision Systems and Infrared Sensing Systems*, and comes with a fully stabilized 3-axis gimbal camera with an equivalent 24-48 mm 2x optical Enterprise lens capable of shooting 4K videos and 12-megapixel photos that support up to 6x FHD zoom. DJI signature technologies such as Obstacle Sensing and the Advanced Pilot Assistance System, help you capture complex shots effortlessly. Additional features like the built-in AirSense makes you aware of your surrounding airspace, and password protection helps you maintain secure access to your aircraft and protect your data. The Mavic 2 Enterprise also has attachable modular accessories like the M2E Spotlight, M2E Beacon and M2E speaker that are purpose built for various applications. The Mavic 2 Enterprise boasts a maximum flight speed of 44.7 mph (72 kph) and a maximum flight time** of 31 minutes.

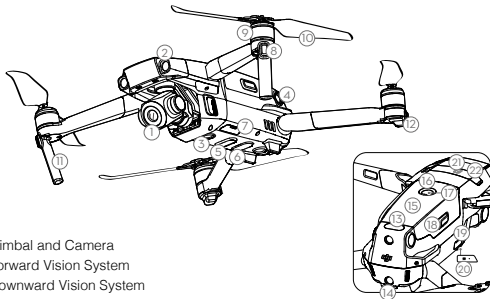

- | | | |
|-------------------------------------|------------------------------------|--|
| 1. Gimbal and Camera | 11. Antennas | 18. Battery Buckles |
| 2. Forward Vision System | 12. Aircraft Status Indicator | 19. USB-C Port |
| 3. Downward Vision System | 13. Upward Infrared Sensing System | 20. Link Button/Linking Status Indicator |
| 4. Lateral Vision System | 14. Backward Vision System | 21. Extended Port (to connect accessories) |
| 5. Downward Infrared Sensing System | 15. Intelligent Flight Battery | 22. Extended Port Cover |
| 6. Auxiliary Bottom Light | 16. Battery Level LEDs | |
| 7. MicroSD Card Slot | 17. Power Button | |
| 8. Front LEDs | | |
| 9. Motors | | |
| 10. Propellers | | |

* The Vision Systems and Infrared Sensing Systems are affected by surrounding conditions. Read the Disclaimer and Safety Guidelines, User Manual, and watch the tutorial videos on the official DJI website to learn more. <http://www.dji.com/mavic-2-enterprise>

** Maximum flight time was tested in an environment with no wind while flying at a consistent 15.5 mph (25 kph). This value is for reference only.

Remote Controller

Built into the remote controller is the DJI's long-range transmission technology OCUSSYNC™ 2.0, offering a maximum transmission range of 5 mi (8 km) and displaying video from the aircraft to the DJI Pilot app on your mobile device at up to 1080p. An on-board LCD screen gives real-time aircraft data information and the detachable control sticks make the remote controller easier to store.

Maximum run time: 2 hours and 15 minutes*



Folded

1. LCD Screen
2. Flight Pause Button
3. 5D Button
4. Removable Control Sticks
5. Power Button
6. Antennas
7. RTH Button
8. Control Sticks Storage Slot
9. Reserve Video-Downlink Port (USB)
10. Mobile Device Clamp
11. Flight Mode Switch

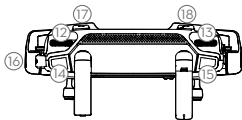
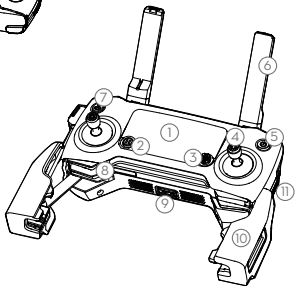

12. Gimbal Dial
13. Zoom Adjustment Dial
14. Record Button
15. Focus/Shutter Button
16. Video-Downlink/Power Port (micro USB)
17. C1 Button (Customizable)
18. C2 Button (Customizable)

* The remote controller is able to reach its maximum transmission distance (FCC) in a wide-open area with no electromagnetic interference at an altitude of about 400 ft (120 m).

The maximum runtime is tested in a laboratory environment. This value is for reference only.

1. Download the DJI Pilot App and Watch the Tutorial Videos

Search "**DJI Pilot**" in the App Store or Google Play or scan the QR code below to download the app on your mobile device.



DJI Pilot

Watch the tutorial videos at www.dji.com/mavic-2-enterprise.



Tutorial videos



DJI Pilot is compatible with iOS 10.0 (or later) or Android 4.4.0 (or later).

2. Preparing the Aircraft

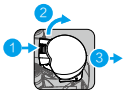

Remove the gimbal cover from the camera.



Unfold the front arms.



Unfold the rear arms.

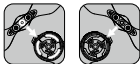

Marked

Unmarked

Match the propellers to motors.



Press the propellers down firmly and rotate in the lock direction.



Unfolded



Unfold the front arms and the propellers before the rear ones. All arms and propellers must be unfolded before takeoff.

3. Charging the Batteries

Use the provided charger to fully charge the Intelligent Flight Battery before first use.

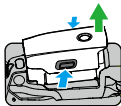

Remove the Intelligent Flight Battery

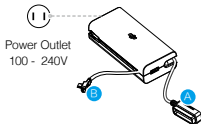

Charging Time:
~1 hour 30 minutes

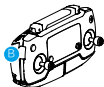

Charging Time:
~2 hour 15 minutes

 Remove the remote controller cable before charging.

• Checking the Battery Levels and Powering On/Off

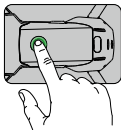

Press once to check the battery level.
Press, then press and hold to turn on/off.

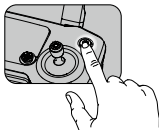

BAT 100 PCT

Press once to check the battery level on
the LCD screen.

Press once, then press and hold to turn on/
off the remote controller.

 Install the battery to the aircraft and power it on. Once the battery temperature is lower than 6° C, it will auto heat to maintain a temperature between 8-10° C. Refer to the User Manual for more details.

4. Preparing the Remote Controller

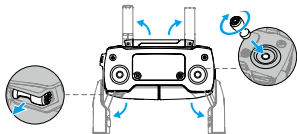

Unfold the antennas and mobile device clamps, then attach the control sticks.



Place one end of the RC cable to the end of the slot.

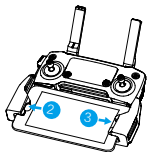

Attach your mobile device within the clamps.



Set the antennas parallel to each other

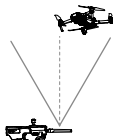
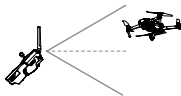

Optimal Transmission Range

- Ensure the control sticks are firmly mounted.
- The remote controller cable with the Lightning connector is mounted by default. Use the appropriate cable for your mobile device to connect to the remote controller. When using an iPad or tablet, use the USB port on the remote controller.
- Do not use the Micro USB and the USB ports simultaneously for linking video.

5. Preparing for Takeoff



Power on the remote controller



Power on the aircraft



Launch DJI Pilot



Internet

Use your DJI account to activate the aircraft. Activation requires an internet connection.



Set a password for the aircraft in the DJI Pilot app to ensure secure access and protect your onboard data.

6. Flight

Before taking off, make sure the Aircraft Status Bar in DJI Pilot displays "Ready to Go".

Ready to Go (GPS)

• Manual Takeoff / Landing

Combination stick command to start/stop the motors



Left stick up (slowly) to take off



Left stick down (slowly) until you touch the ground
Hold a few seconds to stop the motors



The motors can only be stopped mid-flight when the flight controller detects critical error.

• Remote Controller Operation

The default flight control is known as Mode 2. The left stick controls the aircraft's altitude and heading, while the right stick controls its forward, backward, left and right movements. The gimbal dial controls the camera's tilt.

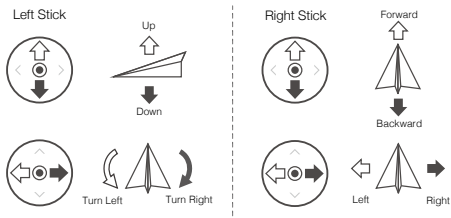

- Always set an appropriate RTH altitude before takeoff. When the aircraft is returning to the Home Point, you should guide it with the control sticks.
- Press the Flight Pause button for emergency braking during flight.

* Modular Accessories



M2E Beacon



M2E Spotlight



M2E Speaker

7. Fly Safe



Fly in Open Areas



Strong GPS Signal



Maintain Line of Sight



Fly Below 400 Feet (120 m)



Avoid flying over or near obstacles, crowds, high voltage power lines, trees or bodies of water.

DO NOT fly near strong electromagnetic sources such as power lines and base stations as it may affect the onboard compass.



DO NOT use the aircraft in adverse weather conditions such as rain, snow, fog and wind speeds exceeding 10 m/s or 22 mph.



Stay away from the rotating propellers and motors.



No Fly Zone

Learn more at:
<http://flysafe.dji.com/no-fly>



It's important to understand basic flight guidelines, for the safety of both you and those around you. Don't forget to read the *Disclaimer and Safety Guidelines*.

Specifications

• Aircraft

Weight	905 g
Max Speed	44.7 mph (72 kph) in Sport mode without wind
Max Service Ceiling Above Sea Level	19685 ft (6000 m)
Operating Temperature	14° to 104° F (-10° to 40° C)
GNSS	GPS + GLONASS
Operating Frequency	2.4-2.4835 GHz; 5.725-5.850 GHz
Transmitter Power (EIRP)	2.4 GHz FCC: ≤26 dBm; CE/MIC: ≤20 dBm; SRRC: ≤20 dBm 5.8 GHz FCC: ≤26 dBm; CE: ≤14 dBm; SRRC: ≤26 dBm
Internal Storage	24 GB

• Gimbal

Controllable Range	Pitch: -90° to +30°
--------------------	---------------------

• Camera

Sensor	1/2.3" CMOS; Effective pixels: 12M
Lens	FOV: approx. 83° (24 mm), approx. 48° (48 mm) 35 mm format equivalent: 24-48 mm Aperture: f/2.8 (24 mm) - f/3.8 (48 mm) Focus: 0.5 m to ∞
ISO Range	Video: 100-3200 Photo: 100-1600 (auto); 100-3200 (manual)
Electronic Shutter Speed	8-1/8000 s
Max Image Size	4000×3000
Still Photography Modes	Single shot Burst shooting: 3/5/7 frames Auto Exposure Bracketing (AEB): 3/5 bracketed frames at 0.7 EV Bias Interval
Video Recording Modes	4K Ultra HD: 3840×2160 24/25/30p 2.7K: 2688×1512 24/25/30/48/50/60p FHD: 1920×1080 24/25/30/48/50/60/120p
Video Storage Bitrate	100 Mbps
Photo	JPEG, DNG (RAW)
Video	MP4, MOV (MPEG-4 AVC/H.264, HEVC)
Supported SD Cards	microSD Max Capacity: 128 GB (UHS-I Speed Grade 3 rating required)

• Remote Controller

Operating Frequency	2.4-2.4835 GHz; 5.725-5.850 GHz
Max Transmission Distance (Unobstructed and free of interference)	FCC: 5 mi (8 km); CE/MIC: 3.1 mi (5 km); SRRC: 3.1 mi (5 km)
Operating Temperature	32° to 104° F (0° to 40° C)

Battery	3950mAh @ 3.83V
Transmitter Power (EIRP)	2.4 GHz FCC: ≤26 dBm; CE/MIC: ≤20 dBm; SRRC: ≤20 dBm 5.8 GHz FCC: ≤26 dBm; CE: ≤14 dBm; SRRC: ≤26 dBm
Operating Voltage	1800mA @ 3.83V (when charging the mobile device)
Supported Mobile Device Size	Thickness supported: 6.5 - 8.5 mm, Max length: 160 mm Supported USB port types: Lightning, Micro USB (Type-B) USB-C
• Charger	
Voltage	17.6±0.1 V
Rated Power	60 W
• Intelligent Flight Battery	
Capacity	3850 mAh
Voltage	17.6 V (max) 15.4 V (typical)
Battery Type	LiPo 4S
Energy	59.29 Wh
Net Weight	Approx. 297 g
Charging Temperature Range	41° to 104° F (5° to 40° C)
Max Charging Power	80 W
Auto Heating Temperature Range	14° to 43° F (-10° to 6° C)
Auto Heating Time	500 s (max)
Auto Heating Power	55 W (max)

For more information, read the User Manual:

www.dji.com/mavic-2-enterprise

※ This content is subject to change without prior notice.

MAVIC is a trademark of DJI.

Copyright © 2018 DJI All Rights Reserved.

Designed by DJI. Printed in China.

认识 Mavic 2 Enterprise

MAVIC™ 2 Enterprise 飞行器配备先进的全方位视觉系统及红外传感系统*，可在室内外稳定悬停、飞行，具备自动返航、障碍物感知以及辅助飞行功能。飞行器内置 DJI AirSense 可检测周围航空器情况，支持密码保护以保障设备及数据安全，并且可搭载指定配件以适应不同应用场景。Mavic 2 Enterprise 配备高精度增稳云台和等效 24-48 mm 的两倍光学变焦镜头，可稳定拍摄 4K 超高清视频与 1200 万像素照片，最高支持 FHD 6 倍变焦。最大飞行速度为 72 km/h，最长飞行时间** 约为 31 分钟。

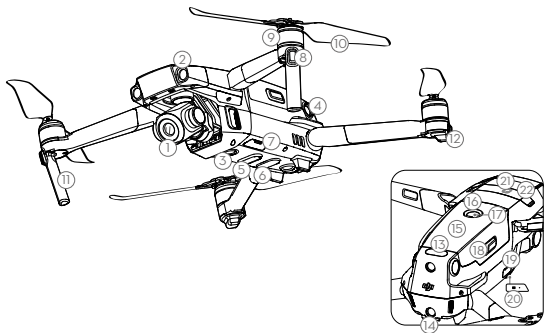

- | | | |
|-------------------|--------------|--------------------------|
| 1. 一体式云台相机 | 10. 螺旋桨 | 17. 电池开关 |
| 2. 前视视觉系统 | 11. 天线 | 18. 电池卡扣 |
| 3. 下视视觉系统 | 12. 飞行器状态指示灯 | 19. 调参 / 数据接口
(USB-C) |
| 4. 侧视视觉系统 | 13. 顶部红外传感系统 | 20. 对频按键 / 对频指示灯 |
| 5. 底部红外传感系统 | 14. 后视视觉系统 | 21. 扩展接口(可连接配件) |
| 6. 下视补光灯 | 15. 智能飞行电池 | 22. 扩展接口保护盖 |
| 7. 相机 Micro SD 卡槽 | 16. 电池电量指示灯 | |
| 8. 飞行器机头指示灯 | | |
| 9. 电机 | | |

* 视觉系统及红外传感系统有使用环境与条件要求，请阅读《免责声明与安全概要》及《用户手册》了解安全注意事项，并在 DJI™ 官方网站观看教学视频以正确使用相关功能。

<http://www.dji.com/mavic-2-enterprise>

** 最长飞行时间为无风环境时以 25 km/h 匀速飞行时测得。

遥控器

Mavic 2 Enterprise 遥控器采用 OCUSYNC™ 2.0 高清图传技术，配合完备的功能按键可在最大 8 千米* 通信距离内完成飞行器与相机的操作与设置，并可通过 DJI Pilot App 在移动设备实时显示高清画面。遥控器状态显示屏可实时显示飞行参数等信息，折叠式手柄可稳定放置移动设备，可拆卸摇杆设计更便于遥控器收纳。最长工作时间* 约为 2 小时 15 分钟。



折叠状态

1. 状态显示屏
2. 急停按键
3. 五维按键
4. 可拆卸摇杆
5. 电源按键
6. 天线
7. 智能返航按键
8. 摇杆收纳槽
9. 备用图传接口 (USB)
10. 手柄
11. 飞行模式切换开关

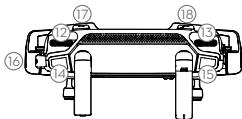
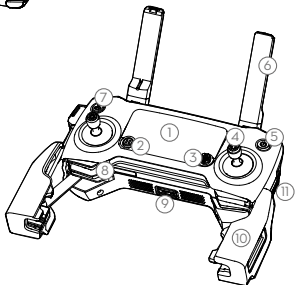

12. 云台俯仰控制拨轮
13. 焦距调节拨轮
14. 录影按键
15. 对焦 / 拍照按键
16. 主图传 / 充电接口 (Micro USB)
17. 自定义功能按键 C1
18. 自定义功能按键 C2

* 在开阔无遮挡、无电磁干扰的环境飞行，并且飞行高度为 120 米左右，在 FCC 标准下遥控器可以达到最大通信距离。最长可工作时间为实验环境下测得，仅供参考。

1. 下载 DJI Pilot App 和观看教学视频

CHS

请使用移动设备扫描下方二维码或在软件商店
下载安装 DJI Pilot App。



下载 DJI Pilot

访问 DJI 官方网站 www.dji.com/mavic-2-enterprise
观看教学视频。



教学视频

 DJI Pilot App 要求使用 iOS 10.0 及以上系统或 Android 4.4.0 及以上系统。

2. 准备飞行器

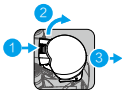

移除云台保护罩



展开前机臂



展开后机臂

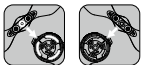

白色标记 无标记

匹配标记安装螺旋桨



嵌入桨座按压到底，沿锁
紧方向旋转直至弹起锁定



展开状态

 请确保按顺序展开机臂，在机臂与桨叶全部展开之后再开启飞行器。

3. 充电

首次使用需给智能飞行电池充满电以激活电池。

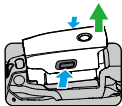

取出智能飞行电池

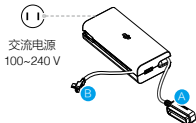

交流电源
100~240 V



完全充满约需
1 小时 30 分钟

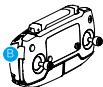

完全充满约需
2 小时 15 分钟

! 充电前需将遥控器转接线取下。

• 检查电量与开启 / 关闭

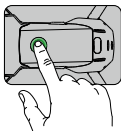

短按一次检查电量。
短按一次，再长按 2 秒可开启、
关闭飞行器。

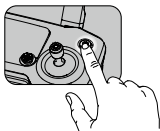

BAT 100 PCT

短按一次电源按钮查看电量。
短按一次电源按钮，再长按 2 秒以开启、
关闭遥控器。

! 安装电池至飞行器后并开启电源后，一旦电池温度低于 6°C，电池将开启自动加热功能，保持电池温度在 8-10°C 之间。详细内容请参考用户手册。

4. 准备遥控器

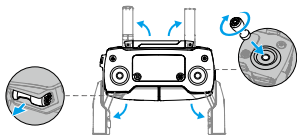

展开天线、手柄，取出收纳于遥控器上的摇杆并安装



使转接线的一端置于卡槽底部

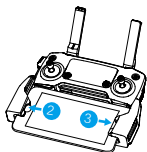

转接线一端连接移动设备接口，
安装移动设备

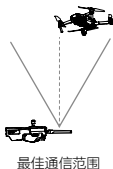
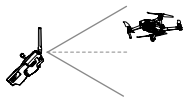

- 注意将摇杆拧紧，确保安装到位。
- 遥控器默认安装 Lightning 接口的转接线，可根据移动设备接口类型更换转接线。若使用 iPad 等较大尺寸移动设备时，可自备数据线连接至遥控器 USB 接口。
- Micro USB 接口与 USB 接口作为图传接口时不可同时使用。

5. 准备飞行



开启遥控器



开启飞行器



运行 DJI Pilot App



Internet

全新的飞行器需使用 DJI Pilot App 激活才能使用。激活时请确保移动设备可以接入互联网。



可在 DJI Pilot App 中对飞行器设置安全密码以保证飞行器的使用安全。

6. 飞行

起飞前请务必等待 DJI Pilot App 相机界面显示“起飞准备完毕”。

起飞准备完毕 (GPS)

• 手动起飞 / 降落

掰杆动作：
电机启动 / 停止



起飞：
缓慢向上推动油门杆（默认左摇杆）飞行器起飞。



降落：
向下拉动油门杆至飞行器落地，在最低位置保持 2 秒，电机停止。



如飞行器在空中检测到严重故障，才可执行掰杆动作以紧急停机。

• 遥控器操作

遥控器出厂默认操控方式为“美国手”。左摇杆控制飞行高度与方向，右摇杆控制飞行器的前进、后退以及左右飞行方向。云台俯仰控制拨轮可控制相机的俯仰拍摄角度。

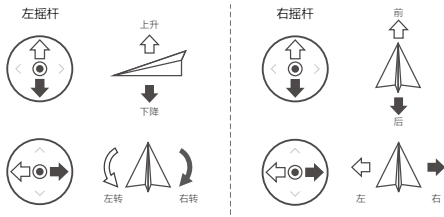

- 请预先在 DJI Pilot App 设置合适的自动返航高度。
- 飞行过程中遇到需要紧急刹车的情况，请按急停按键使飞行器悬停。

* 可扩展配件



夜航灯



探照灯



喊话器

7. 飞行安全



在开阔无遮挡
的环境中飞行

+



GPS信号良好

+



在目视范围内飞行

+



控制飞行高
度低于120米



飞行时请远离人群、树木、电线、高大建筑物、机场和信号发射塔等。无线电发射塔、高压线、变电站以及具有磁性的大块金属可能会对遥控信号及指南针产生干扰，威胁飞行安全。



下雨、大雾、下雪、雷电、大风（风速每秒10米及以上）等天气请勿飞行。



切勿接触旋转中的螺旋桨，
否则可能受到严重人身财产损害。



禁飞区

详情请访问以下网址：
<http://fllysafe.dji.com/no-fly>



禁飞区、飞行安全认识对于您、周围人群与环境的安全非常重要。
请务必仔细阅读《免责声明和安全概要》。

规格参数

• 飞行器

起飞重量	905 g
最大水平飞行速度	72 km/h (运动模式, 海平面附近无风环境)
最大起飞海拔高度	6000 m
工作环境温度	-10°C 至 40°C
GNSS	GPS + GLONASS
工作频率	2.4-2.4835 GHz; 5.725-5.850 GHz
发射功率 (EIRP)	2.4 GHz FCC: ≤26 dBm; CE/MIC: ≤20 dBm; SRRC: ≤20 dBm 5.8 GHz FCC: ≤26 dBm; CE: ≤14 dBm; SRRC: ≤26 dBm
机载内存	24 GB

• 云台

可控转动范围	俯仰: -90° 至 +30°
--------	-----------------

• 相机

影像传感器	1/2.3 英寸 CMOS; 有效像素 1200 万
Lens	视角: 约 83° (24 mm); 约 48° (48 mm) 35 mm 格式等效焦距: 24-48 mm 光圈: f/2.8 (24 mm) - f/3.8 (48 mm) 可对焦范围: 0.5 m 至无穷远
ISO 范围	视频: 100-3200 照片: 100-1600 (自动); 100-3200 (手动)
电子快门速度	8-1/8000 s
最大照片尺寸	4000 × 3000
照片拍摄模式	单张拍摄 多张连拍 (BURST): 3/5/7 张 自动包围曝光 (AEB): 3/5 张 @0.7EV 步长 EV Bias 定时拍摄
录像分辨率	4K Ultra HD: 3840 × 2160 24/25/30p 2.7K: 2688 × 1512 24/25/30/48/50/60p FHD: 1920 × 1080 24/25/30/48/50/60/120p
视频存储最大码流	100 Mbps
图片格式	JPEG, DNG (RAW)
视频格式	MP4, MOV (MPEG-4 AVC/H.264, HEVC)
支持存储卡类型	microSD 卡; 最大支持 128GB 容量, 传输速度达到 UHS-I Speed Grade 3 评级的 microSD 卡

• 遥控器

工作频率	2.4-2.4835 GHz; 5.725-5.850 GHz
最大信号有效距离	FCC: 8 km; CE/MIC: 5 km; SRRC: 5 km
工作环境温度	0°C 至 40°C
电池	3950mAh @ 3.83V
发射功率 (平均 EIRP)	2.4 GHz FCC: ≤26 dBm; CE/MIC: ≤20 dBm; SRRC: ≤20 dBm 5.8 GHz FCC: ≤26 dBm; CE: ≤14 dBm; SRRC: ≤26 dBm
工作电流 / 电压	1800mA @ 3.83V (给外部设备充电时)
支持移动设备	厚度 6.5-8.5 mm, 最大长度 160 mm 接口类型: Lightning, Micro USB (Type-B), USB-C

• 充电器

电压	17.6 ± 0.1 V
额定功率	60 W

• 智能飞行电池

容量	3850 mAh
电压	17.6 V (满充电压) 15.4 V (典型电压)
电池类型	LiPo 4S
能量	59.29 Wh
电池整体重量	约 297 g
充电环境温度	5°C 至 40°C
最大充电功率	80 W
自加热环境温度	-10°C 至 6°C
自加热时间	500 s (最大)
自加热功率	55 W (最大)

了解产品详细信息，请访问以下网址下载《用户手册》

www.dji.com/mavic-2-enterprise

※ 内容如有更新，恕不另行通知。

MAVIC 是大疆创新的商标。

Copyright © 2018 大疆创新 版权所有

Designed by DJI. Printed in China.

認識 Mavic 2 Enterprise

MAVIC™ 2 Enterprise 航拍機配備先進的全方位視覺系統及紅外線傳感系統*，可在室內外穩定懸停、飛行，具備自動返航、障礙物感知以及輔助飛行功能。航拍機內建 DJI AirSense，可偵測周圍航拍機情況，支援密碼保護可保障裝置及資料安全，並且可搭載指定配件以滿足不同應用場景需求。Mavic 2 Enterprise 配備高度精密增穩雲台和等效 24-48mm 的二倍光學變焦鏡頭，可穩定拍攝 4K 超高畫質影片與 1200 萬像素照片，最高可支援 FHD 6 倍變焦。最大飛行速度為 72 km/h，最長飛行時間** 約為 31 分鐘。

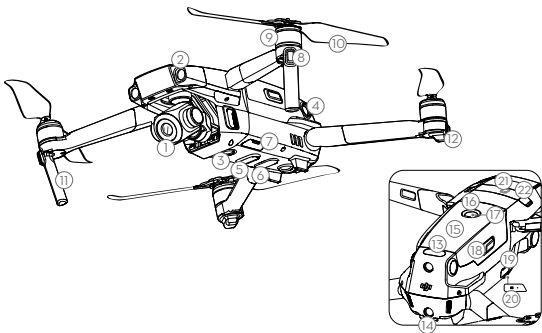

1. 整合式雲台相機
2. 前視視覺系統
3. 下視視覺系統
4. 側視視覺系統
5. 底部紅外線傳感系統
6. 補光燈
7. 相機 Micro SD 卡插槽
8. 航拍機機頭指示燈
9. 馬達
10. 螺旋槳
11. 天線
12. 航拍機狀態指示燈
13. 頂部紅外線傳感系統
14. 後視視覺系統
15. 智能飛行電池
16. 電池電量指示燈
17. 電池開關
18. 電池卡扣
19. 調參 / 數據連接埠 (USB-C)
20. 配對按鈕 / 配對指示燈
21. 擴充接頭 (可連接配件)
22. 擴充接頭保護蓋

* 視視覺系統及紅外線傳感系統有使用環境與條件方面的要求，請閱讀《免責聲明與安全總覽》及《使用者手冊》以了解安全注意事項。另請上 DJI™ 官方網站觀看教學影片，以便正確使用相關功能。

<http://www.dji.com/mavic-2-enterprise>

** 最長飛行時間是在無風環境下，以 25 km/h 等速飛行測得。

遙控器

Mavic 2 Enterprise 遙控器採用 OCUSSYNC™ 2.0 高清圖傳技術，配合完備的功能按鈕，可在最大 8 千公尺 * 通訊距離內完成航拍機與相機的操作與設定，並可通過 DJI Pilot 應用程式在行動裝置即時顯示高畫質畫面。遙控器狀態顯示螢幕可即時顯示飛行參數等資訊，摺疊式把手可穩定放置行動裝置，可拆卸搖桿設計更便於遙控器收納。最長運作時間 * 約為 2 小時 15 分鐘。



摺疊狀態

1. 狀態顯示螢幕
2. 急停按鈕
3. 五維按鈕
4. 可拆卸搖桿
5. 電源按鈕
6. 天線
7. 智能返航按鈕
8. 搖桿收納槽
9. 備用影像傳輸連接埠 (USB)
10. 把手
11. 飛行模式切換開關

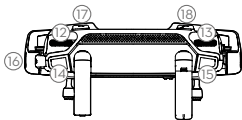
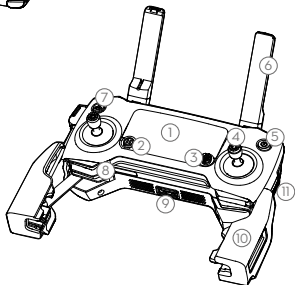

12. 雲台俯仰控制轉盤
13. 焦距調節轉盤
14. 錄影按鈕
15. 對焦 / 拍照按鈕
16. 主要影像傳輸 / 充電連接埠 (Micro USB)
17. 自訂功能按鈕 C1
18. 自訂功能按鈕 C2

* 若在開關無遮擋、無電磁干擾的環境下，於高度 120 公尺左右飛行時，遙控器即可依據 FCC 標準達到最大通訊距離。最長運作時間為實驗室環境下測得，僅供參考。

1. 下載 DJI Pilot App 應用程式並觀看教學影片

請使用行動裝置掃描下方的 QR 碼，或在軟體商店下載安裝 DJI Pilot 應用程式。



下載 DJI Pilot

前往 DJI 官方網站 www.dji.com/mavic-2-enterprise 觀看教學影片。



教學影片

 DJI Pilot 應用程式要求使用 iOS 10.0 及以上系統或 Android 4.4.0 及以上系統。

2. 準備航拍機

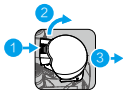

移除雲台保護罩



展開前機臂



展開後機臂

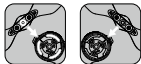

白色標記

無標記

匹配标记安装螺旋桨



嵌入槳座並按壓到底，沿鎖緊方向旋轉直到彈起鎖定



展開狀態

 請確保按順序展開機臂，在機臂與槳葉全部展開之後再開啟航拍機。

3. 充電

首次使用時，必須為智能飛行電池充電以啟動電池。

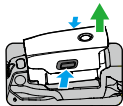

取出智能飛行電池

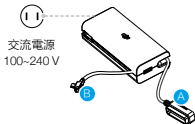

交流電源
100-240 V



完全充電電約需 1 小時
30 分鐘

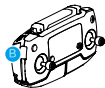

完全充電電約需
2 小時 15 分鐘

 充電前需將遙控器轉接線取下。

• 檢查電量與開啓 / 關閉

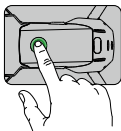

短按一次檢查電量。
短按一次，再長按 2 秒可開啟、
關閉航拍機。

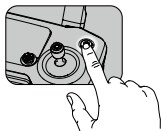

BAT 100 PCT

短按一次電源按鈕以查看電量。
短按一次電源按鈕，再長按 2 秒以開啟、
關閉遙控器。

 在航拍機上安裝電池並開啟電源後，一旦電池溫度低於 6°C，電池將開啟自動加熱功能，讓電池溫度保持在 8 - 10°C 之間。詳細內容請參閱使用者手冊。

4. 準備遙控器

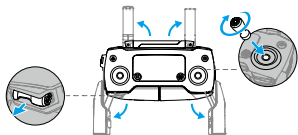

展開天線、把手，取出收納於遙控器上的搖桿並加以安裝



將轉接線的一端置於卡插槽底部

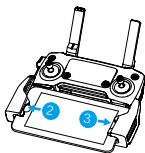

將轉接線一端連接行動裝置連接埠，以安裝行動裝置



強



弱

確保天線平行

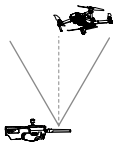
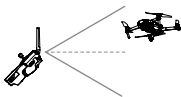

最佳通訊範圍



- 注意將搖桿鎖緊，以確保安裝到位。
- 遙控器預設安裝 Lightning 連接埠的轉接線，但可根據行動設備連接埠類型更換轉接線。若使用 iPad 等尺寸較大的行動裝置，可自備數據傳輸線連接遙控器 USB 連接埠。
- 作為影像傳輸連接埠時，Micro USB 連接埠和 USB 連接埠不可同時使用

5. 準備飛行



開啟遙控器



開啟航拍機



執行 DJI Pilot App
應用程式



Internet

全新的航拍機需使用 DJI Pilot 應用程式啟動才能使用。啟動時請確認行動裝置已連線至網際網路。



可在 DJI Pilot 應用程式中設定航拍機安全密碼以確保航拍機的使用安全。

6. 飛行

起飛前，請務必等待 DJI Pilot 應用程式相機介面顯示「起飛準備完畢」(起飞准备完毕)。

起飛準備完畢 (GPS)

• 手動起飛 / 降落

綜合控制桿指令：

馬達啟動 / 停止



或



起飛：
緩慢向上推動油門桿 (預設左搖桿) 使航拍機起飛。



降落：
向下拉動油門桿至航拍機落地，在最低位置保持 2 秒，馬達接著停止。



如航拍機在空中檢測到嚴重故障，才能執行「綜合控制桿指令」以緊急停機。

遙控器操作

遙控器出廠預設操控方式為「美國手」。左搖桿控制飛行高度與方向，右搖桿控制航拍機的前進、後退以及左右飛行方向。雲台俯仰控制轉盤可控制相機的俯仰拍攝角度。

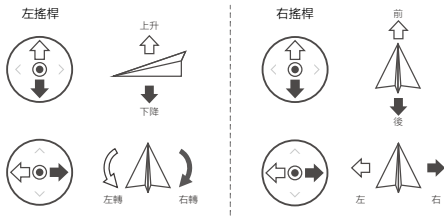

- 请预先在 DJI Pilot App 设置合适的自动返航高度。
- 飞行过程中遇到需要紧急刹车的情况，请按急停按键使飞行器悬停。

* 擴充配件



夜航燈



探照燈



擴音器

7. 飛行安全



在開闊無遮蔽的環境中飛行

+



GPS 訊號良好

+



在視線範圍內飛行

+



將飛行高度控制在 120 公尺以下



飛行時請遠離人群、樹木、電線、高大建築物、機場和訊號發射塔等。無線電發射塔、高壓線、變電站及具有磁性的大型金屬物體均可能對遙控訊號及指南針產生干擾，進而威脅飛行安全。



請勿在下雨、起大霧、下雪、打雷閃電、大風 (風速每秒 10 公尺以上) 等天氣下飛行。



請遠離旋轉中的螺旋槳，否則可能會嚴重危及人身及財產安全。



禁航區

詳情請參閱以下網站：
<http://fllysafe.dji.com/no-fly>



了解禁飛區及飛行安全知識，對於您、周圍人群與環境的安全非常重要。請務必詳讀《免責聲明與安全總覽》。

規格

• 航拍機

起飛重量	905 g
最大水平飛行速度	72 km/h (運動模式, 海平面附近無風環境)
最大起飛海拔高度	6000 m
操作溫度	-20°C至 40°C
GNSS	GPS + GLONASS
操作頻率	2.4-2.4835 GHz; 5.725-5.850 GHz
發射功率 (EIRP)	2.4 GHz FCC: ≤26 dBm; CE/MIC: ≤20 dBm; SRRC: ≤20 dBm 5.8 GHz FCC: ≤26 dBm; CE: ≤14 dBm; SRRC: ≤26 dBm
機載儲存容量	24 GB

• 雲台

可操控轉動範圍	俯仰: -90° 至 +30°
---------	-----------------

• 相機

影像傳感器	1/2.3" 英吋 CMOS, 有效像素 1200 萬
Lens	視角: 約 83° (24 mm), 約 48° (48 mm) 35 mm 格式等效焦距: 24-28 mm 光圈: f/2.8 (24 mm) - f/3.8 (48 mm) 可對焦範圍: 0.5 m 至無限遠
ISO 範圍	影片: 100-3200 照片: 100-1600 (自動); 100-3200 (手動)
電子快門速度	8-1/8000 s
最大照片尺寸	4000 × 3000
照片拍攝模式	單張拍攝 多張連拍 (高速): 3/5/7 畫格 自動包圍曝光 (AEB): 3/5 畫格 @0.7EV 增量 定時拍攝
錄影解像度	4K Ultra HD: 3840 × 2160 24/25/30p 2.7K: 2688 × 1512 24/25/30/48/50/60p FHD: 1920 × 1080 24/25/30/48/50/60/120p
影片儲存最大傳輸速率	100 Mbps
圖片格式	JPEG, DNG (RAW)
影片格式	MP4, MOV (MPEG-4 AVC/H.264, HEVC)
支援的記憶卡類型	microSD 卡; 最大支持 128GB 容量, 传输速度达到 UHS-I Speed Grade 3 等级的 microSD 卡

遙控器

操作頻率	2.4-2.4835 GHz; 5.725-5.850 GHz
最大訊號有效距離	FCC: 8 km; CE/MIC: 5 km; SRRC: 5 km
操作溫度	0°C 至 40°C
電池	3950mAh @ 3.83V
發射功率 (平均 EIRP)	2.4 GHz FCC: ≤26 dBm; CE/MIC: ≤20 dBm; SRRC: ≤20 dBm 5.8 GHz FCC: ≤26 dBm; CE: ≤14 dBm; SRRC: ≤26 dBm
工作電流 / 電壓	1800mA @ 3.83V (為外部設備充電時)
支援行動裝置	厚度 6.5-8.5 mm, 最大長度 160 mm 連接埠類型: Lightning、Micro USB (Type-B)、USB-C

充電器

電壓	17.6 ± 0.1 V
額定功率	60 W

智能飛行電池

容量	3850 mAh
電壓	17.6 V (滿充電壓) 15.4 V (一般電壓)
電池類型	LiPo 4S
能量	59.29 Wh
電池整體重量	約 297 g
充電環境溫度	5°C 至 40°C
最大充電功率	80 W
自動加熱環境溫度	-10°C 至 6°C
自動加熱時間	500 s (最大)
自動加熱功率	55 W (最大)

要了解產品詳細資訊，請造訪以下網址下載《使用者手冊》

www.dji.com/mavic-2-enterprise

※ 內容如有更新，恕不另行通知。

MAVIC 是大疆創新的商標。

Copyright © 2018 大疆創新 版權所有

Designed by DJI. Printed in China.

機体

DJI™ MAVIC™ 2 Enterprise は、全方向ビジョンシステム／赤外線検知システム*に加え、完全な安定性を実現する 24-48mm 相当の光学 2 倍ズームレンズ搭載の 3 軸ジンバルカメラを備え、4K 動画と 12MP の写真を撮影できます。障害物検知や高度操縦支援システム (APSA) など、DJI の代表的な技術を用いて、複雑な撮影シーンも簡単に撮影できます。内蔵型の AirSense といった追加機能により、ユーザーは周囲の空域を把握することができます。また、パスワード保護により、機体への安全なアクセスを確保し、データを保護することができます。Mavic 2 Enterprise には、M2E スポットライト／M2E ピーコン／M2E スピーカーなどの取り付けられるモジュラーアクセサリも用意されています。Mavic 2 Enterprise の最大飛行速度は 72km/h、最大飛行時間** は 31 分です。

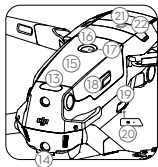
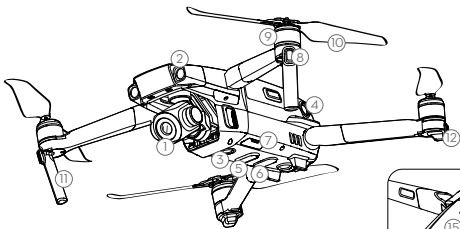

- | | | |
|---------------------|-----------------|----------------|
| 1. ジンバルカメラ | 11. アンテナ | 18. バッテリーパックル |
| 2. 前方ビジョンシステム | 12. 機体ステータスインジ | 19. USB-C ポート |
| 3. 下方ビジョンシステム | ケータ | 20. リンクボタン/リンク |
| 4. 側面ビジョンシステム | 13. 上方赤外線検知システム | ステータスインジ |
| 5. 下方赤外線検知システム | 14. 後方ビジョンシステム | ケータ |
| 6. 底部補助ライト | 15. インテリジェント・ | 21. 拡張ポート (アクセ |
| 7. microSD カード用スロット | フライト・バッテリー | サリ接続用) |
| 8. フロント LED | 16. バッテリー残量 LED | 22. 拡張ポートカバー |
| 9. モーター | 17. 電源ボタン | |
| 10. プロペラ | | |

* ビジョンシステムおよび赤外線検知システムは、周辺環境の条件の影響を受けます。詳細に関しては、免責事項と安全に関するガイドライン/ユーザーマニュアルをお読みになり、公式 DJI ウェブサイトのチュートリアルビデオをご覧ください。 <http://www.dji.com/mavic-2-enterprise>

** 最長飛行時間は無風状態で、定速 25km/h でテストしたものです。この値は参考値です。

送信機

送信機には DJI の長距離伝送技術 OCUSSYNC™ 2.0 が内蔵されているので、最大伝送距離は 8 km（日本国内では 5 km）で、最大 1,080p の動画を機体からモバイル端末の DJI Pilot アプリへ送信し表示します。搭載されている液晶画面にはリアルタイムで機体のデータ情報が表示されます。また、コントロールスティックは着脱可能であるため、送信機の格納が容易です。

最大稼働時間：2 時間 15 分*



折りたたんだ状態

1. LCD 液晶画面
2. フライト一時停止ボタン
3. 5D ボタン
4. 着脱可能コントロールスティック
5. 電源ボタン
6. アンテナ
7. RTH ボタン
8. コントロールスティック格納スロット
9. ビデオ・ダウンリンク・ポート予備 (USB)
10. モバイル端末用クランプ
11. フライトモード・スイッチ

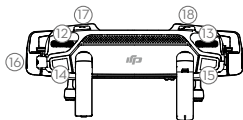
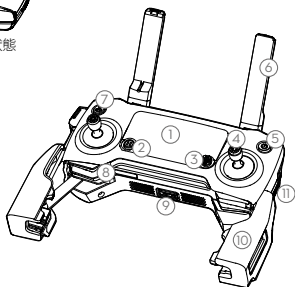

12. ジンバルダイヤル
13. ズーム調整ダイヤル
14. 録画ボタン
15. フォーカス/シャッターボタン
16. ビデオダウンリンク/電源ポート (micro USB)
17. C1 ボタン (カスタマイズ可能)
18. C2 ボタン (カスタマイズ可能)

* 最大伝送距離 (FCC) は、障害物や電波干渉のないエリアで、機体の高度が約 120m のときに有効です。最大稼働時間は、ラボ環境でテストされています。この値は参考値です。

1. DJI Pilot アプリのダウンロードとチュートリアルビデオの視聴

App Store または Google Play で「DJI Pilot」を検索するか、以下の QR コードをスキャンして、お手持ちのモバイル端末にアプリをダウンロードします。



DJI Pilot

チュートリアルビデオは、www.dji.com/mavic-2-enterprise からご覧ください。



チュートリアルビデオ

! DJI Pilot は iOS 10.0 以降および Android 4.4.0 以降と互換性があります。

2. 機体の準備

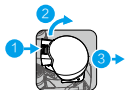

カメラからジンバルカパーを取り外します。



前方アームを展開します。



後方アームを展開します。



マークあり マークなし
プロペラをモーターに
合わせます。



プロペラを下に向かって強く押して、ロック方向へ回転させます。



展開状態

! 前方のアームとプロペラを展開してから、後方のアームとプロペラを展開します。離陸前にすべてのアームとプロペラを展開しておく必要があります。

3. バッテリーの充電

初めて使用する場合は、付属の充電器を使用して、インテリジェント・フライト・バッテリーを完全に充電しておきます。

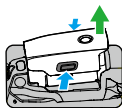

インテリジェント・フライト・
バッテリーの取り外し

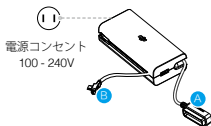

充電時間：
～1時間30分

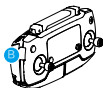

充電時間：
～2時間15分

! 充電する前に送信機のケーブルを取り外します。

・バッテリー残量の確認と電源のオン/オフ

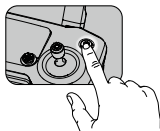
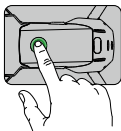

BAT 100 PCT

ボタンを1回押すと、バッテリー残量を
確認できます。

ボタンを押してから、次に長押しすると、
電源がオンまたはオフになります。

ボタンを1回押すと、液晶画面でバッテリー
残量を確認できます。

ボタンを1回押し、次に長押しすると、送
信機の電源がオンまたはオフになります。

! バッテリーを機体に取り付け、電源を入れてください。バッテリー温度が6℃以下になると、自動発熱機能により温度を8～10℃に維持します。詳しくはユーザーマニュアルをご覧ください。

4. 送信機の準備

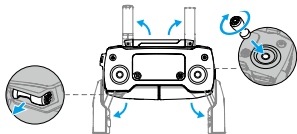

アンテナとモバイル端末用クランプを展開してから、コントロールスティックを取り付けます。



強い



弱い

アンテナをお互いに平行になるように取り付ける

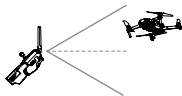

RCケーブルの片端をスロット端に置きます。

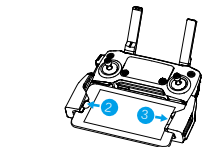

クランプ内にモバイル端末を取り付けます。

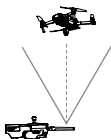

最適な伝送範囲



- コントロールスティックをしっかりと取り付けてください。
- Lightning コネクター付きの送信機ケーブルがデフォルトで装着されています。お使いのモバイル端末を送信機に接続するのに適切なケーブルを使用してください。iPad やタブレットを使用するときは、送信機の USB ポートを使用してください。
- ビデオリンクの際、Micro USB ポートと USB ポートを同時に使用しないでください。

5. 離陸の準備



送信機の電源を入れる



機体の電源を入れる



DJI Pilot を起動する



インターネット

自分の DJI アカウントを使用して機体をアクティベーションします。アクティベーションするにはインターネット接続が必要です。



安全なアクセスと内蔵データの保護を確実にするため、DJI Pilot アプリで機体のパスワードを設定してください。

6. 飛行

離陸する前に、DJI Pilot の機体ステータスバーに「Ready to Go」が表示されていることを確認してください。

Ready to Go (GPS)

・手動での離陸/着陸

コンビネーション・スティック・コマンドでモーター始動/停止



左スティックを
ゆっくり上に倒
して離陸



地面に着くまで、左スティックを（ゆっくりと）下に倒します。
数秒間そのまま保持してから、モーターを停止します。



フライトコントローラーが深刻なエラーを検知したときに限り、飛行中にモーターが停止することがあります。

送信機操作

デフォルトのフライトコントロールはモード2です。左スティックで機体の高度と進行方向、右スティックで前進、後退、右回転、左回転をコントロールします。ジンバルダイヤルでカメラのチルト操作をコントロールします。

左スティック



右スティック



- 離陸前に、必ず適切な Return-to-Home (RTH) 高度を設定してください。機体をホームポイントに戻す際は、コントロールスティックで誘導してください。
- 飛行中に緊急ブレーキをかけるときは、フライト一時停止ボタンを押します。

* モジュラーアクセサリー



M2E ビーコン



M2E スポットライト



M2E スピーカー

7. 安全なフライトのために



開けた場所での
飛行

+



強いGPS信号

+



視界の維持

+



120m未満の高度で
飛行



障害物、人混み、高電圧線、樹木、水域の近くで飛行させないでください。
電線や基地局などの強い電磁波域の周辺では、機体のコンパスが性能を発揮できないことがあるため、飛行させないでください。



雨、雪、霧、風速10m/s超などの悪天候時に機体を使用しないでください。



回転中のプロペラやモーターから
離れてください。



飛行禁止区域

詳細については、以下でご確認ください。
<http://www.dji.com/jp/flysafe/no-fly>



ご自身の安全と周りの人々の安全のため、基本的なフライトガイドラインを理解することが重要です。免責事項および安全に関するガイドラインを必ずお読みください。

仕様

機体

重量	905 g
最大速度	無風、スポーツモードで 72 km/h
運用限界高度	6,000 m
動作環境温度	-10 ~ 40°C
GNSS	GPS + GLONASS
動作周波数	2.4 ~ 2.4835 GHz、5.725 ~ 5.850 GHz (日本国内では 2.4 ~ 2.4835 GHz のみ利用可)
送信機出力 (EIRP)	2.4 GHz FCC : 26 dBm 以下、CE/MIC : 20 dBm 以下、SRRC : 20 dBm 以下 5.8 GHz FCC : 26 dBm 以下、CE : 14 dBm 以下、SRRC : 26 dBm 以下
内部ストレージ	24 GB

ジンバル

操作可能範囲	ピッチ : -90° ~ +30°
--------	-------------------

カメラ

センサー	1/2.3" インチ CMOS、有効ピクセル数 : 12MP
レンズ	FOV : 約 83° (24 mm), 約 48° (48 mm) 35 mm 判換算相当 : 24-48 mm 絞り : f/2.8 (24 mm) - f/3.8 (48 mm) フォーカス : 0.5 m ~ ∞
ISO レンジ	動画 : 100 ~ 3200 静止画 : 100 ~ 1600 (オート)、100 ~ 3200 (マニュアル)
電子シャッター速度	8 ~ 1/8000 秒
最大静止画サイズ	4000 × 3000
静止画モード	シングルショット バーストモード : 3/5/7 フレーム オート露出ブラケット (AEB) : 0.7 EV パイアスでの 3/5 ブラケット インターバル撮影

動画記録モード	4K Ultra HD : 3840 × 2160 24/25/30p 2.7K : 2688 × 1512 24/25/30/48/50/60p FHD : 1920 × 1080 24/25/30/48/50/60/120p
---------	--

最大ビデオビットレート	100 Mbps
静止画	JPEG、DNG (RAW)
動画	MP4、MOV (MPEG-4 AVC/H.264、HEVC)
対応 SD カード	microSD 最大容量 : 128 GB (UHS-I スピードクラス 3 が必要)

送信機

動作周波数	2.4 ~ 2.4835 GHz、5.725 ~ 5.850 GHz (日本国内では 2.4 ~ 2.4835 GHz のみ利用可)
最大伝送距離 (障害物および干渉がないこと)	FCC : 8 km、CE/MIC : 5 km、SRRC : 5 km

動作環境温度	0 ~ 40°C
バッテリー	3950mAh @ 3.83V
送信機出力 (EIRP)	2.4 GHz FCC : 26 dBm 以下、CE/MIC : 20 dBm 以下、SRRC : 20 dBm 以下 5.8 GHz FCC : 26 dBm 以下、CE : 14 dBm 以下、SRRC : 26 dBm 以下
動作電圧	1800mA @ 3.83V (モバイル端末未充電時)
対応モバイル端末 サイズ	対応厚さ : 6.5 ~ 8.5 mm、最大長 : 160 mm 対応 USB ポートタイプ : Lightning、Micro USB (Type B) USB-C
• 充電器	
電圧	17.6 ± 0.1 V
定格出力	60 W
• インテリジェント・フライト・バッテリー	
容量	3850 mAh
電圧	17.6 V (最大) 15.4 V (標準)
バッテリータイプ	LiPo 4S
電力量	59.29 Wh
正味重量	約 297 g
充電温度範囲	5 ~ 40°C
最大充電電力	80 W
自動発熱温度範囲	-10°C ~ 6°C
自動発熱時間	500 秒 (最大)
自動発熱出力	55 W (最大)

詳細については、以下にあるユーザーマニュアルを参照してください。

www.dji.com/mavic-2-enterprise

※ このコンテンツは予告なく変更される場合があります。

MAVIC は DJI の商標です。

Copyright © 2018 DJI All Rights Reserved.

Designed by DJI. Printed in China.

기체

DJI™ MAVIC™ 2 Enterprise에는 전방위 비전 시스템과 적외선 감지 시스템*은 물론이고, 4K 동영상 및 12메가픽셀 사진을 촬영할 수 있는 24~48mm 2배 광학 줌 렌즈가 장착되어 최대 6배 FHD 줌을 지원하는 완전히 안정화된 3축 짐벌 카메라가 갖추어져 있습니다. 장애물 감지 및 고급 파일럿 보조 시스템(APAS)과 같은 DJI 시그니처 기술을 사용하면 복잡한 장면도 손쉽게 촬영할 수 있습니다. 내장된 AirSense와 같은 추가 기능으로 주변 공역에 무엇이 있는지 알 수 있습니다. 또한 비밀번호 보안은 기체에 안전하게 액세스할 수 있게 해주고 데이터를 보호해줍니다. 맥빅 2 Enterprise는 M2E 스포트라이트, M2E 비콘, M2E 스피커와 같은 장착 가능한 모듈식 액세서리가 있어 다양한 용도로 활용할 수 있습니다. Mavic 2 Enterprise는 72km/h(44.7mph)의 최대 비행 속도와 31분에 이르는 최대 비행 시간**을 자랑합니다.

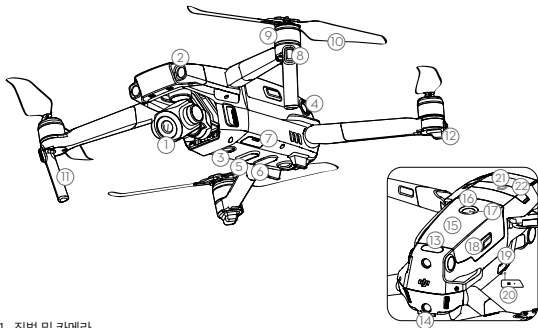

- | | |
|------------------|---------------------|
| 1. 짐벌 및 카메라 | 10. 프로펠러 |
| 2. 전방 비전 시스템 | 11. 안테나 |
| 3. 하향 비전 시스템 | 12. 기체 상태 표시기 |
| 4. 측방 비전 시스템 | 13. 상향 적외선 감지 시스템 |
| 5. 하향 적외선 감지 시스템 | 14. 후방 비전 시스템 |
| 6. 보조광 | 15. 인텔리전트 플래이트 배터리 |
| 7. microSD 카드 슬롯 | 16. 배터리 잔량 LED |
| 8. 전방 LED | 17. 전원 버튼 |
| 9. 모터 | 18. 배터리 버클 |
| | 19. USB-C 포트 |
| | 20. 연동 버튼/연동 상태 표시기 |
| | 21. 확장 포트(액세서리 연결용) |
| | 22. 확장 포트 커버 |

* 비전 시스템 및 적외선 감지 시스템은 주변 환경의 영향을 받습니다. 고지사항 및 안전 가이드와 사용자 매뉴얼을 읽고, 공식 DJI 웹사이트에서 튜토리얼 영상을 시청하여 자세히 알아보십시오. <http://www.dji.com/mavic-2-enterprise>

** 최대 비행시간은 지속적인 25km/h(15.5mph)의 무풍 환경에서 테스트했습니다. 이 값은 참조용으로만 사용해야 합니다.

조종기

조종기에 내장된 DJI 장거리 전송 기술인 OCUSSYNC™ 2.0을 통해 8km(5마일)의 최대 전송 범위를 제공하고 기체에서 모바일 기기의 DJI Pilot 앱까지 최대 1080p 디스플레이 동영상을 전송이 가능합니다. 내장 LCD 화면에 실시간 기체 데이터 정보가 표시되며 조종 스틱은 분리가 가능해 조종기를 더 쉽게 보관할 수 있습니다.

최대 작동 시간: 2시간 15분*



접은 상태

1. LCD 화면
2. 비행 일시 정지 버튼
3. 5D 버튼
4. 탈착식 제어 스틱
5. 전원 버튼
6. 안테나
7. RTH 버튼
8. 조종 스틱 보관 슬롯
9. 예비 동영상 다운로드 포트 (USB)
10. 모바일 기기 클램프
11. 비행 모드 전환

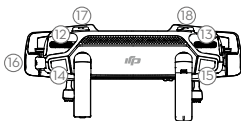
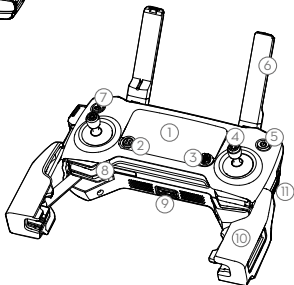

12. 짐벌 다이얼
13. 줌 조정 다이얼
14. 녹화 버튼
15. 초점/셔터 버튼
16. 동영상 다운로드/전원 포트(마이크로 USB)
17. C1 버튼(사용자 지정 가능)
18. C2 버튼(사용자 지정 가능)

* 조종기는 전자기 간섭이 없는 확 트인 넓은 야외에서 비행하는 경우 고도 약 120미터(400피트)에서 최대 전송 거리(FCC)까지 도달할 수 있습니다.

최대 지속 시간은 시험실 환경에서 테스트되었습니다. 이 값은 참조용으로만 사용해야 합니다.

1. DJI Pilot 앱 다운로드 및 튜토리얼 영상 시청

App Store 또는 Google Play에서 "DJI Pilot"를 검색하거나 아래의 QR 코드를 스캔하여 앱을 모바일 기기에 다운로드합니다.



DJI Pilot

www.dji.com/mavic-2-enterprise 에서 튜토리얼 영상을 시청하십시오.



튜토리얼 영상

! DJI Pilot는 iOS 10.0 이상 또는 Android 4.4.0 이상과 호환됩니다.

2. 기체 준비

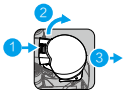

카메라에서 짐벌 커버를 분리합니다.



전방 암을 펴니다.



후방 암을 펴니다.

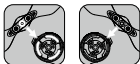

표시됨 표시되지 않음

모터에 프로펠러를 연결합니다.



프로펠러를 아래 방향으로 세게 누르고 잠금 방향으로 돌립니다.



편 상태

! 앞쪽 암과 프로펠러를 펴고 뒤쪽 암을 펴니다. 이륙 전에 모든 암과 프로펠러를 펴야 합니다.

3. 배터리 충전

처음 사용하기 전에 제공된 충전기를 사용하여 인텔리전트 플라이트 배터리를 완전히 충전합니다.

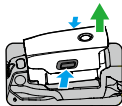

인텔리전트 플라이트 배터리 제거

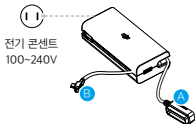

전기 콘센트
100~240V



충전 시간:
1시간 30분 미만

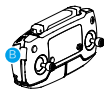

충전 시간:
2시간 15분 미만

! 충전하기 전에 조종기 케이블을 분리하십시오.

• 배터리 잔량 확인 및 전원 켜기/끄기

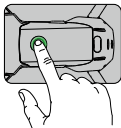

한 번 눌러 배터리 잔량을 확인합니다.
누른 다음 다시 길게 누르면 켜지거나 꺼집니다.

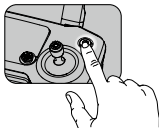

BAT 100 PCT

LCD 화면에서 한 번 눌러 배터리 수준을 확인합니다.

한 번 누른 다음 길게 누르면 조종기가 켜지거나 꺼집니다.

! 기체에 배터리를 장착하고 전원을 켭니다. 배터리 온도가 6°C보다 낮아지면 자동으로 발열하여 8~10°C 사이의 온도를 유지합니다. 자세한 내용은 사용자 매뉴얼을 참조하십시오.

4. 조종기 준비

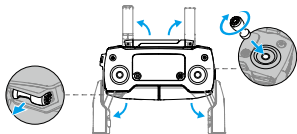

안테나와 모바일 기기 클램프를 편 다음
조종 스틱을 장착합니다.

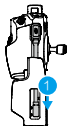

RC 케이블의 한쪽 끝을 슬롯의
끝에 연결합니다.

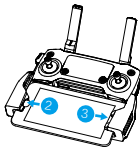

클램프 내에서 모바일 기기를 연결합니다.



안테나를 서로 평행하게 설정

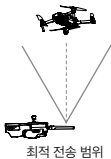
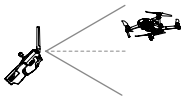

최적 전송 범위



- 조종 스틱이 단단히 장착되었는지 확인하십시오.
- 라이트닝 커넥터가 있는 조종기 케이블이 기본적으로 장착됩니다. 모바일 기기에 알맞은 케이블을 사용하여 조종기에 연결하십시오. iPad 또는 태블릿을 사용할 때 조종기에서 USB 포트를 사용하십시오.
- 동영상을 연동할 때 마이크 USB와 USB 포트를 동시에 사용하지 마십시오.

5. 이륙 준비



조종기 전원을 켭니다.



기체의 전원을 켭니다.



DJI Pilot를 실행합니다.



인터넷

사용자의 DJI 계정을 사용하여 기체를 활성화합니다. 활성화하려면 인터넷에 연결해야 합니다.



DJI Pilot 앱에서 기체 비밀번호를 설정하여 안전하게 액세스하고 내부 데이터를 보호하십시오.

6. 비행

이륙하기 전에 DJI Pilot의 기체 상태 표시줄에 'Ready to Go'가 표시되어 있는지 확인합니다.

Ready to Go(GPS)

• 수동 이륙/착륙

스틱 조합 명령으로 모터를 시동/중지합니다.



또는



왼쪽 스틱을 위로 움직여(느리게) 이륙합니다.



지면에 닿을 때까지 왼쪽 스틱을 천천히 아래로 내립니다. 몇 초 동안 유지하면 모터를 중지됩니다.



비행 컨트롤러에서 심각한 오류를 감지한 경우에만 비행 도중에 모터를 중지할 수 있습니다.

• 조종기 조작

기본 비행 제어 방법은 모드 2입니다. 왼쪽 스틱은 기체의 고도 및 방향을 제어하고 오른쪽 스틱은 전진, 후진, 왼쪽 또는 오른쪽 이동을 제어합니다. 짐벌 다이얼은 카메라의 틸트를 제어합니다.

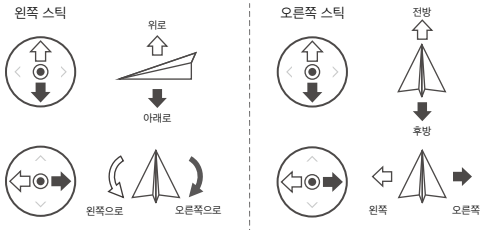

- 이륙하기 전에 항상 적절한 RTH 고도를 설정하십시오. 기체가 홈 포인트로 돌아올 때에는 조종 스틱으로 유도해야 합니다.
- 비행 도중 긴급 제동해야 할 경우 Flight Pause 버튼을 누르십시오.

* 모듈식 액세서리



M2E 바콘



M2E 스포트라이트



M2E 스피커

7. 비행 안전



시야가 확보된 넓은
지역에서 비행

+



강력한 GPS
신호

+



시야 유지

+



120m(400피트) 고도
미만에서 비행



장애물, 군중, 고압 전선, 나무 또는 수계 상공이나 근처에서 비행하지 마십시오.
전선 및 기지국에서 발생하는 강력한 전자기기는 내장 콤팩스에 영향을 줄 수 있으므로 이런
지역 근처에서 비행하지 마십시오.



10m/초 이상

비, 눈, 안개, 10m/초(22mph) 이상의 강풍이 부는 악천후에서는 기체를 사용하지
마십시오.



회전하는 프로펠러와 모터에서 멀리 떨어져
계십시오.



비행 금지 구역

자세한 정보:

<http://flysafe.dji.com/no-fly>



본인과 주변의 안전을 위해 기본 비행 지침을 반드시 숙지해야 합니다. 고지 사항 및 안전 가이드
를 잊지 말고 읽어보십시오.

사양

•기체

무게

905g

최대 속도

바람이 없을 때 스포츠 모드에서 72km/h(44.7mph)

최대 실용 상승 한계 고도(해발)

6,000m(19,685피트)

작동 온도

-10°~40°C(14°~104°F)

GNSS

GPS + GLONASS

작동 주파수

2.4~2.4835GHz, 5.725~5.850GHz

송신기 전원
(EIRP)

2.4GHz

FCC: 26dBm 이하, CE/MIC: 20dBm 이하, SRRC: 20dBm 이하

5.8GHz

FCC: 26dBm 이하, CE: 14dBm 이하, SRRC: 26dBm 이하

내부 저장 장치

24 GB

•짐벌

제어 가능 범위

피치: -90°~+30°

•카메라

센서

1/2.3" 인치 CMOS, 유효 픽셀: 12M

렌즈

FOV: 약 83° (24 mm), 약 48° (48 mm)

35 mm 포맷에 해당: 24-48 mm

조리개: f/2.8 (24 mm) - f/3.8 (48 mm)

초점: 0.5 m ~ ∞

ISO 범위

동영상: 100~3,200

사진: 100~1,600(자동), 100~3,200(수동)

전자 셔터 속도

8~1/8000초

최대 이미지 크기

4000×3000

스틸 사진 모드

단일 촬영

연속 촬영: 3/5/7프레임

AEB(자동 노출 브래케팅): 0.7 EV 바이어스에서 3/5 브래킷 프레임
인터벌

동영상 녹화 모드

4K Ultra HD: 3840×2160 24/25/30p

2.7K: 2688×1512 24/25/30/48/50/60p

FHD: 1920×1080 24/25/30/48/50/60/120p

동영상 저장 비트전송율

100Mbps

사진

JPEG, DNG(RAW)

동영상

MP4, MOV(MPEG-4 AVC/H.264, HEVC)

지원되는 SD 카드

Micro SD

최대 용량: 128GB(UHS-I Speed Grade 3 등급 필요)

•조종기

작동 주파수

2.4~2.4835GHz, 5.725~5.850GHz

최대 전송 거리
(장애물과 간섭이 없는 경우)

FCC: 8km(5마일), CE/MIC: 5km(3.1마일), SRCC: 5km(3.1마일)

작동 온도

0°~40°C(32°~104°F)

배터리	3950mAh @ 3.83V
송신기 전원 (EIRP)	2.4GHz FCC: 26dBm 이하, CE/MIC: 20dBm 이하, SRRC: 20dBm 이하 5.8GHz FCC: 26dBm 이하, CE: 14dBm 이하, SRRC: 26dBm 이하
작동 전압	1800mA @ 3.83V(모바일 기기 충전 시)
지원되는 모바일 기기 크기	지원되는 두께: 6.5~8.5mm, 최대 길이: 160mm 지원되는 USB 포트 유형: Lightning, Micro USB(Type-B) USB-C
• 충전기	
전압	17.6±0.1V
정격 출력	60W
• 인텔리전트 플라이트 배터리	
용량	3850mAh
전압	17.6V(최대) 15.4V(일반)
배터리 유형	LiPo
에너지	59.29Wh
순중량	약 297g
충전 온도 범위	5°~40°C(41°~104°F)
최대 충전 전력	80W
자동 발열 온도 범위	-10° ~ 6° C
자동 발열 시간	500초 (최대)
자동 발열 전력	55 W (최대)

자세한 내용은 사용자 매뉴얼을 확인하십시오.
www.dji.com/mavic-2-enterprise

※ 본 내용은 사전 고지 없이 변경될 수 있습니다.

MAVIC은 DJI의 상표입니다.

Copyright © 2018 DJI All Rights Reserved.

Designed by DJI. Printed in China.

Fluggerät

Die DJI™ MAVIC™ 2 Enterprise verfügt über ein omnidirektionales Sichtsystem, Infrarotsensorsystem* und eine voll stabilisierte 3-Achsen-Gimbal-Kamera, deren Objektiv mit 2-fachem optischen Zoom 24 – 48 mm entspricht und Videos mit 4K aufzeichnet, sowie Fotos mit 12 MP aufzeichnen kann. Es wird bis zu vierfacher verlustfreier Zoom bei Aufzeichnungen in FHD unterstützt. Die bekannten fortschrittlichen Technologien von DJI, wie das fortschrittliche Assistenzsystem für Piloten (APAS) und die Hinderniserkennung unterstützen beim Meistern komplexer Aufnahmen. Zusätzliche Funktionen wie das eingebaute DJI AirSense informieren Sie über den Luftraum in Ihrer Nähe. Der integrierte Passwortschutz schützt Ihre Daten auf der Drohne vor unbefugtem Zugriff. Die Mavic 2 Enterprise lässt sich darüber hinaus durch modulares Zubehör, wie dem M2E Scheinwerfer, dem M2E Positionslicht und dem M2E Lautsprecher für verschiedene Anwendungsszenarien erweitern. Die Mavic 2 Enterprise besticht durch eine maximale Fluggeschwindigkeit von 72 km/h und eine maximale Flugzeit** von 31 Minuten.

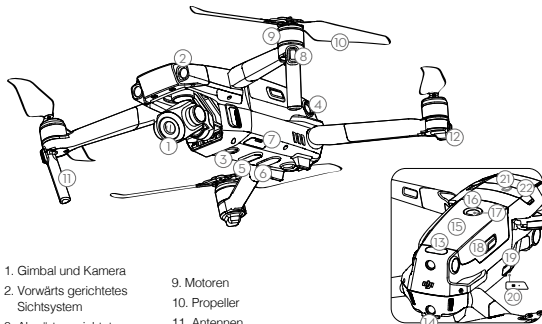

- | | |
|--|--|
| 1. Gimbal und Kamera | 9. Motoren |
| 2. Vorwärts gerichtetes Sichtsystem | 10. Propeller |
| 3. Abwärts gerichtetes Sichtsystem | 11. Antennen |
| 4. Seitliches Sichtsystem | 12. Statusanzeige des Fluggeräts |
| 5. Nach unten gerichtetes Infrarotsensorsystem | 13. Nach oben gerichtete Infraroterkennung |
| 6. Hilfsbeleuchtung | 14. Rückwärts gerichtetes Sichtsystem |
| 7. Einschub für die Micro-SD-Karte | 15. Intelligent Flight Battery |
| 8. Vordere LEDs | 16. Akkuladestatus-LED |
| | 17. Ein/Aus-Taste |
| | 18. Batterieklammern |
| | 19. USB-C-Anschluss |
| | 20. Koppeltaste/Kopplungsstatus-LED |
| | 21. Erweiterungssteckplatz (Zur Anbindung von Zubehör) |
| | 22. Abdeckung des Erweiterungssteckplatzes |

* Die Sicht- und Infrarotsensorsysteme reagieren empfindlich auf die Umgebungsbedingungen. Lesen Sie zu Ihrer Information die Bedienungsanleitung, die Sicherheitsrichtlinien und Ausschlüsse und sehen Sie sich unsere Tutorial-Videos auf der offiziellen DJI Webseite an. <http://www.dji.com/mavic-2-enterprise>

** Die maximale Flugzeit wurde ohne Wind und bei einer konstanten Geschwindigkeit von 25 km/h getestet. Dieser Wert dient nur als Referenz.

Fernsteuerung

In die Fernbedienung integriert ist DJIs Langstrecken-Übertragungstechnologie OCUSYNC™ 2.0, die eine maximale Übertragungsweite von 8 km und die Videoübertragung vom Fluggerät an die DJI Pilot App auf Ihrem Mobilgerät mit bis zu 1080p ermöglicht. Das integrierte LCD-Display liefert in Echtzeit wichtige Informationen zum Fluggerät, und die abnehmbaren Steuerknüppel erleichtern das Verstauen.

Maximale Betriebszeit: 2 Std. und 15 Minuten*



Zusammengeklappt

1. LCD-Bildschirm
2. Flugpausentaste
3. 5D-Taste
4. Abnehmbare Steuerknüppel
5. Ein/Aus-Taste
6. Antennen
7. Rückkehrtaste
8. Staufach für Steuerknüppel
9. USB-Anschluss (Assistant Video-Downlink)
10. Mobilgeräteklammer
11. Flugmodussschalter
12. Gimbal-Rädchen

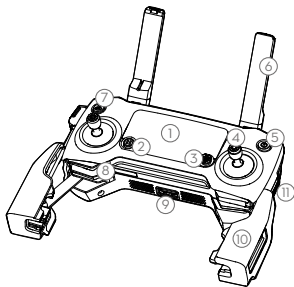

13. Zoom-Einstellrädchen
14. Videotaste
15. Taste für Fokus/Verschluss
16. Video-Downlink-/Lade-Anschluss (Micro-USB)
17. C1-Taste (frei belegbar)
18. C2-Taste (frei belegbar)

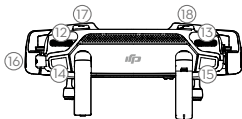

* Die Fernsteuerung erreicht ihre maximale Übertragungsreichweite (FCC) auf offenem Gelände ohne elektromagnetische Störquellen bei einer Flughöhe von ca. 120 m.

Die maximale Laufzeit wurde unter Laborbedingungen getestet. Dieser Wert dient nur als Referenz.

1. Die DJI Pilot App herunterladen und Video-Tutorials ansehen

Suchen Sie im App Store oder auf Google Play nach „DJI Pilot“ oder scannen Sie den QR-Code, um die App auf Ihr Mobilgerät herunterzuladen.



DJI Pilot

Schauen Sie sich die Tutorial-Videos unter folgender Adresse an: www.dji.com/mavic-2-enterprise.



Video-Tutorials



DJI Pilot ist mit iOS 10.0 (oder höher) sowie Android 4.4.0 (oder höher) kompatibel.

2. Fluggerät vorbereiten

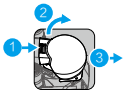

Entfernen Sie die Gimbal-Abdeckung von der Kamera.



Klappen Sie die vorderen Arme aus.



Klappen Sie die hinteren Arme aus.



Markiert



Nicht markiert



Drücken Sie die Propeller herunter, und drehen Sie sie in die Verriegelungsrichtung.



Ausgeklappt



Klappen Sie die vorderen Arme und die Propeller aus, bevor Sie die hinteren Arme ausklappen. Vor dem Losfliegen müssen alle Arme und Propeller ausgeklappt sein.

3. Die Akkus laden

Verwenden Sie das im Lieferumfang enthaltene Ladegerät, um die Intelligent Flight Battery vor der ersten Verwendung vollständig aufzuladen.

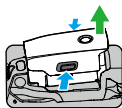

Intelligent Flight Battery entnehmen.

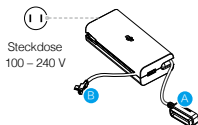

Steckdose
100 - 240 V



Ladezeit:
ca. 1 Std. 30 Minuten

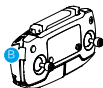

Ladezeit:
ca. 2 Std. 15 Minuten



Das Fernsteuerungskabel muss vor dem Aufladen entfernt werden.

* Ladezustand prüfen und Ein/Ausschalten

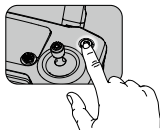
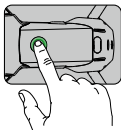

Drücken Sie die Taste einmal, um den Akku-Ladezustand zu überprüfen.
Drücken Sie die Taste einmal kurz und dann lang, um das Gerät ein-/auszuschalten.

BAT 100 PCT

Drücken Sie die Taste einmal, um den Akkuladezustand auf dem LCD-Display zu überprüfen.

Drücken Sie die Taste noch einmal, und halten Sie sie gedrückt, um die Fernsteuerung ein-/auszuschalten.



Legen Sie den Akku in die Drohne und schalten Sie diese ein. Kühlt sich der Akku auf weniger als 6°C ab, erwärmt sich dieser automatisch, um seine Temperatur zwischen 8 und 10 °C zu halten. Für weitere Details schauen Sie bitte in der Bedienungsanleitung nach.

4. Fernsteuerung vorbereiten

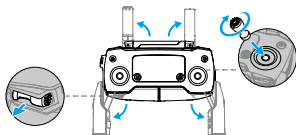

Klappen Sie die Antennen und die Mobilgeräteklammern auf, und montieren Sie die Steuerknüppel.



Stecken Sie ein Ende des RC-Kabels in das Ende des Schlitzes.

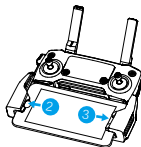

Sichern Sie Ihr Mobilgerät mit den Klammern.



Stark



Schwach

Stellen Sie die Antennen parallel zueinander ein

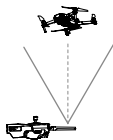
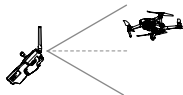

Optimaler Sendebereich



- Stellen Sie sicher, dass die Steuerknüppel fest montiert sind.
- Das Fernsteuerungskabel mit dem Lightning-Anschluss ist standardmäßig montiert. Verwenden Sie zur Verbindung mit der Fernsteuerung das richtige Kabel für Ihr Mobilgerät. Wenn Sie ein iPad oder Tablet verwenden, nutzen Sie den USB-Anschluss der Fernsteuerung.
- Verwenden Sie die Micro-USB- und USB-Anschlüsse nie gleichzeitig für die Videoverbindung.

5. Vorbereitung für den Start



Fernsteuerung einschalten



Fluggerät einschalten



DJI Pilot starten



Verwenden Sie Ihr DJI-Konto, um das Fluggerät zu aktivieren. Für die Aktivierung wird eine Internetverbindung benötigt.



Legen Sie in der DJI Pilot App bitte ein Passwort für die Drohne fest und sichern somit den Zugriff auf den internen Speicher ab.

6. Flug

Vergewissern Sie sich vor dem Losfliegen, dass die Statusleiste in DJI Pilot „Bereit“ anzeigt.

Ready to Go (GPS)

* Automatisches Starten/Landen

Knüppelkombination zum Ein-/
Ausschalten der Motoren



Linken Knüppel langsam
nach oben bewegen,
um zu starten



Drücken Sie den linken Knüppel nach unten
(langsam), bis das Fluggerät den Boden berührt.
Einige Sekunden halten, um die Motoren
auszuschalten



Die Motoren können während des Fluges nur gestoppt werden, wenn der Flugcontroller einen kritischen Fehler erkennt.

* Die Fernsteuerung verwenden

Die Standard-Flugsteuerung wird als Modus 2 bezeichnet. Mit dem linken Steuerknüppel steuern Sie die Höhe und Flugrichtung des Fluggeräts, und mit dem rechten Steuerknüppel steuern Sie ihre Vorwärts-, Rückwärts-, Links- oder Rechtsbewegung. Mit dem Gimbal-Rädchen wird die Neigung der Kamera verstellt.

Linker Knüppel



Steigflug



Sinkflug



Linksdrehung

Rechtsdrehung

Rechter Knüppel



Vorwärts



Rückwärts



Links

Rechts



- Stellen Sie vor jedem Start immer eine geeignete Höhe für die Rückkehrfunktion ein. Wenn das Fluggerät zum Startpunkt zurückkehrt, sollten Sie es mit den Steuerknüppeln korrigieren, falls nötig.
- Drücken Sie die Taste „Flugpausentaste“ zur Notbremsung während des Fluges.

* Modulares Zubehör



M2E Kollisionswarnlicht



M2E Scheinwerfer



M2E Lautsprecher

7. Sicher fliegen



Nur in offenen
Bereichen fliegen

+



Starkes
GPS-Signal

+



Sichtkontakt
behalten

+



Fliegen Sie unterhalb
von 120 m.



Über- und umfliegen Sie Hindernisse, Menschenmengen, Hochspannungsleitungen, Bäume und Gewässer stets mit ausreichendem Sicherheitsabstand.

Fliegen Sie NICHT in die Nähe elektromagnetischer Quellen (z. B. Hochspannungsleitungen, Basisstationen), da die Funktion des Bordkompasses dadurch gestört werden kann.



Fliegen Sie NICHT bei widrigem Wetter (z. B. Regen, Schnee, Nebel oder Windgeschwindigkeiten über 10 m/s).



Halten Sie ausreichend Abstand zu den
drehenden Propellern und Motoren.



Flugverbotszonen
(GEO-Zone)

Mehr Informationen:
<http://flysafe.dji.com/no-fly>



Um Ihre eigene Sicherheit und die Sicherheit der Menschen in Ihrer Umgebung zu gewährleisten, ist es wichtig, dass Sie die nötigen Grundregeln kennen. Lesen Sie sich den **Haftungsausschluss und die Sicherheitsvorschriften durch.**

Technische Daten

• Fluggerät

Gewicht	905 g
Max. Fluggeschwindigkeit	72 km/h im Sportmodus ohne Wind
Max. Dienstgipfelhöhe über N.N.	6.000 m
Betriebstemperatur	-10° bis 40 °C
GNSS	GPS + GLONASS
Betriebsfrequenz	2,4-2,4835 GHz; 5,725-5,850 GHz
Sendeleistung (EIRP)	2,4 GHz FCC: ≤26 dBm; CE/MIC: ≤ 20 dBm; SRRC: ≤20 dBm 5,8 GHz FCC: ≤26 dBm; CE: ≤14 dBm; SRRC: ≤26 dBm
Interner Speicher	24 GB

• Gimbal

Kontrollierter Bereich	Nickachse: -90° bis +30°
------------------------	--------------------------

• Kamera

Sensor	1/2.3"-CMOS, tatsächliche Pixelanzahl: 12M
Objektiv	FOV: ca. 83° (24 mm), ca. 48° (48 mm) entspricht 35-mm-Format: 24-48 mm Blendenzahl: f/2.8 (24 mm)-f/3.8 (48 mm) Fokus: 0.5 m bis ∞
ISO-Bereich	Video: 100 – 3200 Fotos: 100 – 1600 (Auto); 100 – 3200 (manuell)
Belichtungszeit	8 – 1/8000 s
Max. Bildgröße	4000×3000
Fotomodi	Einzelaufnahme Serienbildaufnahme: 3/5/7 Bilder Belichtungsreihe: 3/5 fokussierte Frames bei Blendenöffnung 0,7 Intervall
Videoaufnahmemodi	4K Ultra HD: 3840×2160 24/25/30p 2.7K: 2688×1512 24/25/30/48/50/60p FHD: 1920×1080 24/25/30/48/50/60/120p
Bitrate des Videospeichers	100 Mb/s
Foto	JPEG, DNG (RAW)
Video	MP4, MOV (MPEG-4 AVC/H.264, HEVC)
Unterstützte SD-Speicherkarten	microSD Max. Speicherkapazität: 128 GB (UHS-I Geschwindigkeitsklasse 3 benötigt)

• Fernsteuerung

Betriebsfrequenz	2,4-2,4835 GHz; 5,725-5,850 GHz
Sendereichweite (bei direkter Sichtverbindung und ohne Störungen)	FCC: 8 km; CE/MIC: 5 km; SRRC: 5 km
Betriebstemperatur	0 bis 40 °C
Akku	3950 mAh bei 3,83 V

Sendeleistung (EIRP)	2,4 GHz FCC: ≤26 dBm; CE/MIC: ≤ 20 dBm; SRRC: ≤20 dBm 5,8 GHz FCC: ≤26 dBm; CE: ≤14 dBm; SRRC: ≤26 dBm
Betriebsspannung	1800 mA bei 3,83 V (beim Laden des Mobilgeräts)
Unterstützte Mobilgerätegröße	Unterstützte Dicke 6,5...8,5 mm, max. Länge: 160 mm Unterstützte USB-Porttypen Lightning, Micro-USB (Typ B) USB-C
* Ladegerät	
Spannung	17,6 ± 0,1 V
Nennleistung	60 W
* Intelligent Flight Battery	
Kapazität	3850 mAh
Spannung	17,6 V (max.) 15,4 V (normal)
Akkutyp	LiPo 4S
Energie	59,29 Wh
Nettogewicht	ca. 297 g
Ladetemperatur	5 bis 40 °C
Max. Ladeleistung	80 W
Temperaturbereich der Selbsterwärmung	-10° bis 6° C
Dauer der Selbsterwärmung	Max. 500 Sekunden
Selbsterwärmungsleistung	Max. 55 Watt

Nähere Informationen finden Sie in der Bedienungsanleitung:
www.dji.com/mavic-2-enterprise

※ Der Inhalt kann jederzeit unangekündigt geändert werden.

MAVIC ist eine Marke von DJI.
 Copyright © 2018 DJI Alle Rechte vorbehalten.

Gestaltung: DJI. Gedruckt in China.

Aeronave

La aeronave DJI™ MAVIC™ 2 Enterprise tiene un Sistema de Detección Omnidireccional, que incluye sensores infrarrojos*, así como una cámara con estabilizador en 3 ejes y un objetivo equivalente a 24-48 mm con zoom óptico de 2 aumentos, capaz de capturar vídeos 4K y fotos de 12 megapíxeles compatibles con zoom FHD de 6 aumentos. Las tecnologías características de DJI, tales como la detección de obstáculos y el Sistema Avanzado de Asistencia al Piloto, le permiten capturar tomas complejas sin esfuerzo. Otras funciones como AirSense le permiten ser consciente de su espacio aéreo circundante y la protección por contraseña le ayuda a mantener asegurado el acceso a su aeronave y a proteger su información. El Mavic 2 Enterprise tiene además módulos accesorios como el Foco M2E, la Baliza M2E y el Altavoz M2E, diseñados para una gran variedad de usos. Mavic 2 Enterprise alcanza una velocidad de vuelo máxima de 72 km/h (44,7 mph) y un tiempo máximo de vuelo de 31 minutos**.

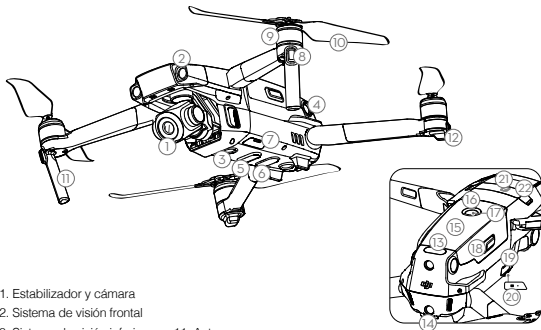

1. Estabilizador y cámara

2. Sistema de visión frontal

3. Sistema de visión inferior

4. Sistema de visión lateral

5. Sistema de detección inferior por infrarrojos

6. Luz inferior auxiliar

7. Ranura para tarjeta microSD

8. Indicadores LED delanteros

9. Motores

10. Hélices

11. Antenas

12. Indicador de estado de la aeronave

13. Sistema de detección superior por infrarrojos

14. Sistema de visión de retroceso

15. Batería de Vuelo Inteligente

16. Indicadores LED de nivel de batería

17. Botón de encendido

18. Bandas de sujeción de la batería

19. Puerto USB-C

20. Botón de vinculación/ indicador de estado de vinculación

21. Puerto de accesorios

22. Tapa del puerto de accesorios

* El sistema de visión y el sistema de detección por infrarrojos se ven afectados por las condiciones del entorno.

Lea la Renuncia de responsabilidad y directrices de seguridad, el Manual del usuario y vea los vídeos tutoriales en la página web de DJI para más información. <http://www.dji.com/mavic-2-enterprise>

** El tiempo máximo de vuelo se determinó en un entorno sin viento a una velocidad sostenida de 25 km/h (15,5 mph). Este valor se proporciona sólo como referencia.

Control remoto

El control remoto lleva incorporada la tecnología de transmisión de largo alcance de DJI, OCUSSYNC™ 2.0, que ofrece un alcance de transmisión máximo de 8 km (5 millas) y permite visualizar video de la aeronave en la aplicación DJI Pilot de su dispositivo móvil en 1080p. La pantalla LCD integrada ofrece información sobre la aeronave en tiempo real, mientras que las palancas de control desmontables facilitan el almacenamiento del control remoto.

Tiempo de funcionamiento máximo: 2 hora y 15 minutos*



Plegado

1. Pantalla LCD
2. Botón de pausa durante vuelo
3. Botón 5D
4. Palancas de control extraíbles
5. Botón de encendido
6. Antenas
7. Botón RTH
8. Ranura de almacenamiento de las palancas de control
9. Puerto de transmisión de video de reserva (USB)
10. Abrazadera para dispositivo móvil
11. Interruptor de modo de vuelo

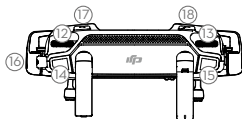
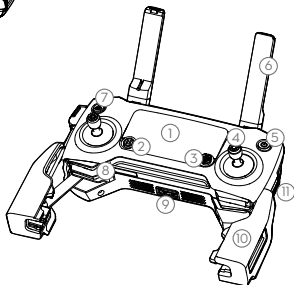

12. Dial del estabilizador
13. Dial de ajuste del zoom
14. Botón de grabación
15. Obturador/botón de enfoque
16. Puerto de alimentación/transmisión de vídeo (microUSB)
17. Botón C1 (personalizable)
18. Botón C2 (personalizable)

* El control remoto es capaz de alcanzar su distancia máxima de transmisión (FCC) en una amplia zona abierta sin interferencias electromagnéticas y a una altitud de unos 120 metros (400 pies). El tiempo de funcionamiento máximo se ha probado en un entorno de laboratorio. Este valor se proporciona sólo como referencia.

1. Descarga de la aplicación DJI Pilot y visualización de los videotutoriales

Busque "DJI Pilot" en la App Store o en Google Play, o escanee el código QR siguiente para descargar la aplicación en su dispositivo móvil.



DJI Pilot

Mire los videos tutoriales en www.dji.com/mavic-2-enterprise.



Videotutoriales

! La aplicación DJI Pilot es compatible con iOS 10.0 (o posterior) y Android 4.4.0 (o posterior).

2. Preparación de la aeronave

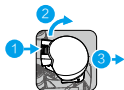

Retire la cubierta del estabilizador de la cámara.



Despliegue los brazos delanteros.



Despliegue los brazos traseros.

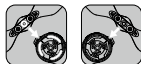

Con marca Sin marca
Empareje las hélices con los motores.



Presione las hélices hacia abajo firmemente y gírelas en la dirección de bloqueo.



Desplegado

! Despliegue los brazos y hélices frontales antes que los posteriores. Todos los brazos y hélices deben estar desplegados antes del despegue.

3. Carga de las baterías

Utilice el cargador suministrado para cargar completamente la Batería de Vuelo Inteligente antes del primer uso.

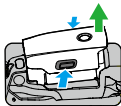

Extraiga la Batería de Vuelo Inteligente



Toma de alimentación
100 - 240 V



Tiempo de carga:
~1 hora y 30 minutos

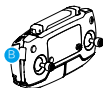

Tiempo de carga:
~2 horas y 15 minutos



Retire el cable del control remoto antes de cargar.

• Comprobar los niveles de batería y encendido/apagado

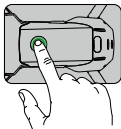

Pulse una vez para comprobar el nivel de batería.

Pulse una vez, después otra y mantenga pulsado para encender o apagar.

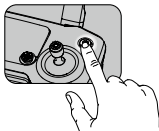

Pulse una vez para comprobar el nivel de batería en la pantalla LCD.

Pulse una vez, después otra y mantenga pulsado para encender o apagar el control remoto.



Instale la batería en la aeronave y enciéndala. Si la temperatura de la batería desciende por debajo de 6 °C, se autocalentará para mantener una temperatura de entre 8 y 10 °C. Consulte el Manual de usuario para más detalles.

4. Preparación del controlador remoto

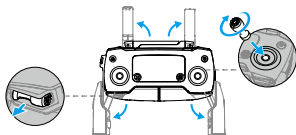

Despliegue las antenas, las abrazaderas del dispositivo móvil y fije las palancas de control.



Coloque las antenas paralelas entre sí.



Coloque un extremo del cable de RC en el extremo de la ranura.

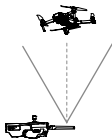
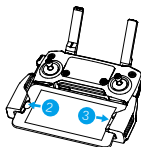
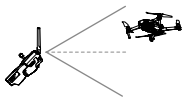

Intervalo de transmisión óptimo

Acople el dispositivo móvil dentro de las abrazaderas.



- Compruebe que las palancas de control estén bien montadas.
- El cable del control remoto con el conector Lightning viene montado de forma predeterminada. Utilice el cable adecuado para conectar el dispositivo móvil al control remoto. Si utiliza un iPad o una tableta, utilice el puerto USB del control remoto.
- No utilice el cable micro USB ni los puertos USB de forma simultánea para conectar vídeo.

5. Preparación para el despegue



Encienda el controlador remoto.



Encienda la aeronave.



Inicie DJI Pilot.



Utilice su cuenta DJI para activar la aeronave. La activación requiere conexión a Internet.



Establezca una contraseña para la aeronave con la aplicación DJI Pilot para garantizar la seguridad de los datos de a bordo.

6. Vuelo

Antes de despegar, asegúrese de que la barra de estado de la aeronave en la aplicación DJI Pilot muestre "Ready to Go".

Ready to Go (GPS)

* Despegue/aterrizaje manuales

Comando de combinación de palancas para arrancar/detener los motores

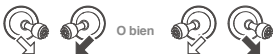

Palanca izquierda arriba (despacio) para despegar



Palanca izquierda abajo (despacio) hasta tocar suelo
Mantenga unos segundos para detener los motores



Los motores sólo se pueden detener en pleno vuelo cuando el controlador de vuelo detecta un error crítico.

* Funcionamiento del control remoto

El control de vuelo predeterminado se conoce como Modo 2. La palanca izquierda controla la altitud y la dirección de la aeronave, mientras que la derecha controla los movimientos hacia delante, atrás, izquierda y derecha. El selector del estabilizador controla la inclinación de la cámara.

Palanca izquierda



Palanca derecha



- Establezca siempre una altitud de RTH (Regreso al punto de origen) adecuada antes del despegue. Cuando la aeronave esté volviendo al punto de origen, debe guiarla con las palancas de control.
- Pulse el botón de pausa de vuelo para una frenada de emergencia durante el vuelo.

* Módulos accesorios



Baliza M2E



Foco M2E



Altavoz M2E

7. Vuelo seguro



Vuele en espacios abiertos

+



Señal fuerte de GPS

+



Mantenga una línea de visión directa

+



Vuele por debajo de 120 m (400 pies)



Evite volar por encima o cerca de obstáculos, multitudes, líneas de alta tensión, árboles o masas de agua.

NO vuele cerca de fuentes electromagnéticas, como tendidos eléctricos y estaciones base, ya que puede afectar a la brújula de a bordo.



NO utilice la aeronave en condiciones climáticas adversas como lluvia, nieve, niebla ni con una velocidad del viento superior a 10 m/s o 22 mph.



Manténgase alejado de las hélices y los motores en rotación.



Zona GEO

Obtenga más información en:
<http://fllysafe.dji.com/no-fly>



Es importante conocer las directrices básicas de vuelo para su propia seguridad y la de quienes le rodean. No olvide leer la *Renuncia de responsabilidad y las directrices de seguridad*.

Especificaciones

• Aeronave

Peso	905 g
Velocidad máxima	72 km/h (44,7 mph) en modo Sport sin viento
Altitud de servicio máxima por encima del nivel del mar	6000 m (19685 ft)
Temperatura de funcionamiento	-10 a 40 °C (14 a 104 °F)
GNSS	GPS + GLONASS
Frecuencia de funcionamiento	2,4-2,4835 GHz; 5,725-5,850 GHz
Potencia del transmisor (PIRE)	2,4 GHz FCC: ≤ 26 dBm; CE/MIC: ≤ 20 dBm; SRRC: ≤ 20 dBm 5,8 GHz FCC: ≤ 26 dBm; CE: ≤ 14 dBm; SRRC: ≤ 26 dBm
Almacenamiento interno	24 GB

• Estabilizador

Intervalo controlable	Cabeceo: -90° a +30°
-----------------------	----------------------

• Cámara

Sensor	CMOS de 1/2,3"; píxeles efectivos: 12 M
Objetivo	FOV: approx. 83° (24 mm), approx. 48° (48 mm) Equivalente a formato de 35 mm: 24-48 mm Apertura: f/2,8 (24 mm)-f/3,8 (48 mm) Enfoque: 0,5 m a ∞
Intervalo de ISO	Vídeo: 100-3200 Fotografía: 100-1600 (automático); 100-3200 (manual)
Velocidad de obturador electrónico	8-1/8000 s
Tamaño de imagen máximo	4000×3000
Modos de fotografía fija	Disparo simple Disparo en ráfagas: 3/5/7 fotografías Exposición automática en horquillado (AEB): 3/5 fotografías horquilladas con sesgo de 0,7 EV Intervalo
Modos de grabación de vídeo	4K Ultra HD: 3840×2160 24/25/30p 2,7K: 2688×1512 24/25/30/48/50/60p FHD: 1920×1080 24/25/30/48/50/60/120p
Tasa de bits de almacenamiento de vídeo	100 Mbps
Fotografía	JPEG, DNG (RAW)
Vídeo	MP4, MOV (MPEG-4 AVC/H.264, HEVC)
Tarjetas SD admitidas	microSD Capacidad máxima: 128 GB (se necesita clasificación de velocidad clase 3 o UHS-I)

• Control remoto

Frecuencia de funcionamiento	2,4-2,4835 GHz; 5,725-5,850 GHz
Distancia de transmisión máx. (Sin obstáculos y sin interferencias)	FCC: 8 km (5 mi); CE/MIC: 5 km (3,1 mi); SRRC: 5 km (3,1 mi)



Temperatura de funcionamiento	De 0 °C a 40 °C (de 32 °F a 104 °F)
Batería	3950 mAh a 3,83 V
Potencia de transmisión (PIRE)	2,4 GHz FCC: ≤ 26 dBm; CE/MIC: ≤ 20 dBm; SRRC: ≤ 20 dBm 5,8 GHz FCC: ≤ 26 dBm; CE: ≤ 14 dBm; SRRC: ≤ 26 dBm
Voltaje de funcionamiento	1800 mA a 3,83 V (al cargar el dispositivo móvil)
Tamaño admitido de dispositivo móvil	Espesor admitido: 6,5-8,5 mm, longitud máxima: 160 mm Tipos de puerto USB compatibles: Lightning, Micro USB (tipo B) USB-C

• Cargador

Voltaje	17,6±0,1 V
Potencia nominal	60 W

• Batería de Vuelo Inteligente

Capacidad	3850 mAh
Voltaje	17,6 V (máx.) 15,4 V (típico)
Tipo de batería	LiPo 4S
Energía	59,29 Wh
Peso neto	Aprox. 297 g
Intervalo de temperatura de carga	De 5 °C a 40 °C (de 41 °F a 104 °F)
Potencia de carga máx.	80 W
Intervalo de temperatura de autocalentamiento	de -10° a 6° C (de 14° a 433° F)
Tiempo de autocalentamiento	500 s (máx)
Potencia de autocalentamiento	55 W (máx)

Para obtener más información, lea el manual del usuario:
www.dji.com/mavic-2-enterprise

※ Este contenido puede modificarse sin notificación previa.

MAVIC es una marca comercial de DJI.
Copyright © 2018 DJI Todos los derechos reservados.

Diseñado por DJI. Impreso en China.

Appareil

Le MAVIC™ 2 Entreprise de DJI™ dispose d'un système de détection d'obstacles omnidirectionnel qui inclut des capteurs infrarouges*. Il est fourni avec une caméra fixée sur une nacelle à 3 axes parfaitement stable, dotée d'un objectif à zoom optique 2x 24 – 48 mm (équivalent au format 35 mm) capable d'enregistrer des vidéos 4K et de prendre des photos de 12 mégapixels, compatible avec un zoom FHD allant jusqu'à 6x. Les technologies emblématiques de DJI telles que la détection d'obstacles et le système d'assistance avancée du pilote vous aident à réaliser des prises de vue complexes sans effort. Des fonctionnalités supplémentaires comme le DJI AirSense intégré vous permettent de connaître l'espace aérien environnant, tandis que la protection par mot de passe vous aide à sécuriser l'accès à votre drone et à protéger vos données. Le Mavic 2 Entreprise dispose également d'accessoires modulaires amovibles tels que le projecteur, le phare et le haut-parleur qui sont spécialement conçus pour diverses applications. Le Mavic 2 Entreprise peut se targuer d'une vitesse de vol maximale de 72 km/h (44,7 mph) et d'un temps de vol maximum de 31 minutes**.

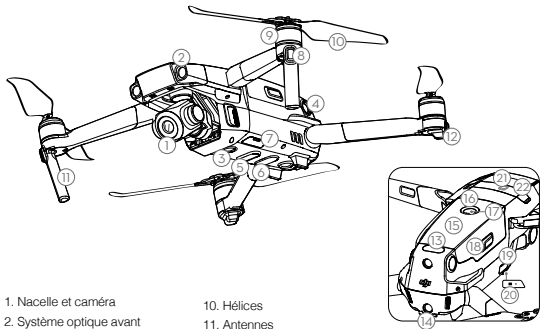

- | | |
|--|---|
| 1. Nacelle et caméra | 10. Hélices |
| 2. Système optique avant | 11. Antennes |
| 3. Système optique inférieur | 12. Voyant d'état de l'appareil |
| 4. Système optique latéral | 13. Système de détection infrarouge vers le haut |
| 5. Système de détection infrarouge vers le bas | 14. Système optique arrière |
| 6. Lampe inférieure | 15. Batterie de Vol Intelligente |
| 7. Logement de la carte microSD | 16. Indicateurs de niveau de batterie |
| 8. LED avant | 17. Bouton d'alimentation |
| 9. Moteurs | 18. Bouton presseur de la batterie |
| | 19. Port USB-C |
| | 20. Bouton d'appairage/voyant d'état d'appairage |
| | 21. Port d'extension (pour connecter les accessoires) |
| | 22. Couverture port d'extension |

* Les systèmes infrarouge et de vision sont influencés par les conditions environnementales. Lisez la clause d'exclusion de responsabilité et les consignes de sécurité ainsi que le guide de l'utilisateur, et regardez les tutoriels vidéo sur le site web officiel de DJI pour en savoir plus. <http://www.dji.com/mavic-2-entreprise>

** Le temps de vol maximum a été testé en l'absence de vent, à une vitesse constante de 25 km/h (15,5 mph). Cette valeur est fournie à titre indicatif uniquement.

Radiocommande

Intégrée à la radiocommande, la technologie de transmission à longue portée OCUSYNC™ 2.0 de DJI offre une portée de transmission maximale de 8 km (5 mi) et permet de transmettre des vidéos de l'appareil vers l'application DJI Pilot installée sur votre appareil mobile en 1080p. Un écran LCD embarqué affiche en temps réel les données de l'appareil tandis que les manches de contrôle amovibles facilitent le rangement de la radiocommande.

Temps de fonctionnement maximal : 2 heures et 15 minutes*



Plié

1. Écran LCD
2. Bouton Pause de la fonction Vol
3. Bouton 5D
4. Manches de contrôle amovibles
5. Bouton d'alimentation
6. Antennes
7. Bouton RTH
8. Emplacement de rangement des manches de contrôle
9. Port Video-Downlink (USB) de réserve
10. Bride de fixation pour appareil mobile
11. Commutateur de mode de vol

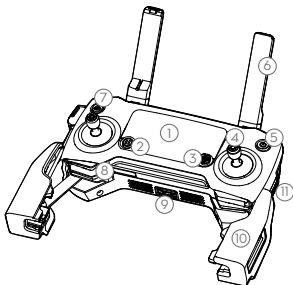

FR

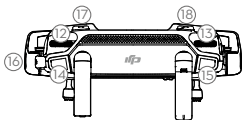

12. Molette de la nacelle
13. Molette de réglage du zoom
14. Bouton d'enregistrement
15. Bouton de mise au point/d'obturateur
16. Port d'alimentation/Video-Downlink (micro USB)
17. Bouton C1 (personnalisable)
18. Bouton C2 (personnalisable)

* La radiocommande peut atteindre une distance de transmission maximale (FCC) dans une zone dégagée sans interférences électromagnétiques et à une altitude d'environ 120 mètres (400 pieds). Le temps d'exécution maximum a été testé dans un environnement de laboratoire. Cette valeur est fournie à titre indicatif uniquement.

1. Téléchargement de l'application DJI Pilot et visionnage des didacticiels vidéo

Recherchez « DJI Pilot » sur l'App Store ou sur Google Play, ou scannez le code QR ci-dessous pour télécharger l'application sur votre appareil mobile.



Application

Regardez les tutoriels vidéo sur www.dji.com/mavic-2-enterprise.



Didacticiels vidéo

! DJI Pilot est compatible avec iOS 10.0 (ou version ultérieure) ou Android 4.4.0 (ou version ultérieure).

2. Préparation de l'appareil

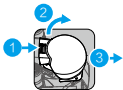

Retirez le cache de la nacelle de la caméra.



Dépliez les bras avant.



Dépliez les bras arrière.

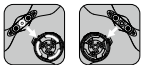

Associez les hélices aux moteurs correspondants.



Montez solidement l'hélice, puis tournez dans la direction de verrouillage.



Déplié

! Dépliez les bras avant et les hélices avant ceux situés à l'arrière. Tous les bras et les hélices doivent être dépliés avant le décollage.

3. Chargement des batteries

Chargez entièrement la Batterie de Vol Intelligente à l'aide du chargeur fourni avant la première utilisation.

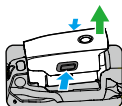

Retirez la Batterie de Vol Intelligente

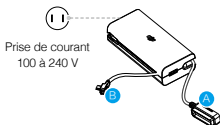

Temps de charge :
environ 1 heure et
30 minutes

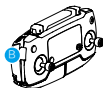

Temps de charge :
environ 2 heures et
15 minutes

 Retirez le câble de la radiocommande avant de la charger.

* Vérification des niveaux de batterie et mise sous/hors tension

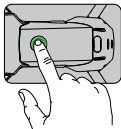

Appuyez une fois pour vérifier le niveau de la batterie.

Appuyez, puis maintenez enfoncé pour allumer/éteindre.

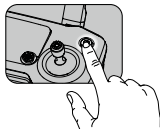

BAT 100 PCT

Appuyez une fois pour vérifier le niveau de batterie sur l'écran LCD.

Appuyez une fois, puis maintenez enfoncé pour allumer/éteindre la radiocommande.

 Installez la batterie dans l'appareil et mettez-le sous tension. Une fois que la température de la batterie est inférieure à 6°C, elle se réchauffe automatiquement pour maintenir une température entre 8 et 10°C. Reportez-vous au guide d'utilisateur pour plus de détails.

4. Préparation de la radiocommande

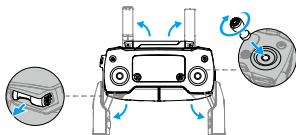

Dépliez les antennes et la bride de fixation pour appareil mobile, puis fixez les manches de contrôle.



Placez une extrémité du câble RC dans le logement.

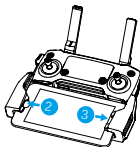

Fixez votre appareil mobile dans les brides de fixation.



Fort



Faible

Installez les antennes de façon parallèle l'une à l'autre

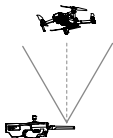
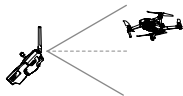

Plage de transmission optimale



- Assurez-vous que les manches de contrôle sont bien en place.
- Le câble de la radiocommande doté du connecteur Lightning est monté par défaut. Utilisez le câble adapté à votre appareil mobile pour brancher ce dernier à la radiocommande. Avec un iPad ou une tablette, utilisez le port USB de la radiocommande.
- N'utilisez pas les ports USB et Micro-USB simultanément pour la liaison vidéo.

5. Préparation au décollage



Mettez la radiocommande sous tension



Mettez l'appareil sous tension



Lancez DJI Pilot



Internet

Utilisez votre compte DJI pour activer l'appareil. L'activation nécessite une connexion Internet.

FR



Définissez un mot de passe pour le drone dans l'application DJI Pilot afin de sécuriser l'accès et de protéger vos données embarquées.

6. Vol

Avant de procéder au décollage, vérifiez dans DJI Pilot que la mention « Ready to Go » s'affiche dans la barre d'état de l'appareil.

Ready to Go (GPS)

• Décollage/atterrissage manuel

Commande de manche combinée pour démarrer/couper les moteurs



Relevez lentement le manche gauche pour décoller.



Abaissez lentement le manche gauche jusqu'à ce que l'appareil touche le sol. Maintenez la position pendant quelques secondes pour couper les moteurs.



Les moteurs peuvent être coupés en plein vol uniquement lorsque le contrôleur de vol détecte une erreur critique.

* Fonctionnement de la radiocommande

Le contrôle de vol par défaut est connu sous le nom de Mode 2. Le manche gauche agit sur l'altitude et l'orientation de l'appareil, tandis que le manche droit contrôle ses mouvements vers l'avant, l'arrière, la gauche et la droite. La molette de la nacelle contrôle l'inclinaison de la caméra.

Manche gauche

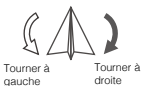

Manche droit

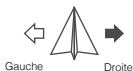

- Définissez toujours une altitude RTH appropriée avant le décollage. Lorsque l'appareil retourne au point de départ, guidez-le avec les manches de contrôle.
- Appuyez sur le bouton Pause de la fonction Vol pour effectuer un freinage d'urgence en plein vol.

* Accessoires modulaires



Phare M2E



Projecteur M2E



Haut-parleur M2E

7. Voler en toute sécurité



Faire voler l'appareil dans des espaces ouverts

+



Signal GPS fort

+



Garder l'appareil en vue

+



Voler à moins de 120 m d'altitude (400 pieds)



Évitez de faire voler l'appareil au-dessus ou à proximité d'obstacles, de rassemblements de personnes, de lignes électriques à haute tension, d'arbres ou d'étendues d'eau. Ne faites PAS voler l'appareil à proximité de sources électromagnétiques puissantes, telles que des lignes électriques ou des antennes relais. Celles-ci risquent en effet d'affecter le compas intégré.



N'utilisez PAS l'appareil dans de mauvaises conditions météorologiques (pluie, neige, brouillard, rafales dont la vitesse dépasse 10 m/s ou 35 km/h [22 mph], etc.).



Tenez-vous à distance des hélices et des moteurs en rotation.



Zone d'exclusion aérienne

Pour en savoir plus, rendez-vous sur le site : <http://flysafe.dji.com/no-fly>



Il est important que vous compreniez les consignes de vol fondamentales afin d'assurer votre sécurité et celle de votre entourage. N'oubliez pas de lire la **Clause d'exclusion de responsabilité et les consignes de sécurité**.

Caractéristiques techniques

• Appareil

Poids	905 g
Vitesse max.	72 km/h (44,7 mph) en mode Sport sans vent
Plafond pratique max. au-dessus du niveau de la mer	6 000 m (19 685 pieds)
Température de fonctionnement	-10 à 40° C (14 à 104° F)
GNSS	GPS + GLONASS
Fréquence de fonctionnement	2,4 à 2,4835 GHz ; 5,725 à 5,850 GHz
Puissance de l'émetteur (EIRP)	2,4 GHz FCC : ≤ 26 dBm ; CE/MIC : 20 dBm ; SRRC : ≤ 20 dBm 5,8 GHz FCC : ≤ 26 dBm ; CE : 14 dBm ; SRRC : ≤ 26 dBm
Stockage interne	24 Go

• Nacelle

Plage réglable	Angle vertical : -90 à +30°
----------------	-----------------------------

• Caméra

Capteur	CMOS 1/2.3" ; pixels effectifs : 12M
Objectif	Champ de vision : env. 83° (24 mm), env. 48° (48 mm) équivalent 35 mm : 24-48 mm Ouverture : f/2.8 (24 mm) - f/3.8 (48 mm) Mise au point : 0.5 m à ∞
Plage ISO	Vidéo : 100 à 3200 Photo : 100 à 1600 (Auto) ; 100 à 3200 (Manuel)
Vitesse d'obturation électronique	8 à 1/8000 s
Taille max. de l'image	4000 × 3000
Mode de photographie	Prise de vue unique Prise de vue en rafale : 3/5/7 clichés Bracketing d'exposition (AEB) : 3/5 clichés en bracketing à 0,7 EV Intervalle
Modes d'enregistrement vidéo	Ultra HD 4K : 3840 × 2160 24/25/30p 2,7K : 2688 × 1512 24/25/30/48/50/60p FHD : 1920 × 1080 24/25/30/48/50/60/120p
Bitrates de stockage vidéo	100 Mbit/s
Photo	JPEG, DNG (RAW)
Vidéo	MP4, MOV (MPEG-4 AVC/H.264, HEVC)
Cartes SD prises en charge	Micro SD Capacité max. : 128 Go (UHS-I Speed catégorie 3 requise)

• Radiocommande

Fréquence de fonctionnement	2,4 à 2,4835 GHz ; 5,725 à 5,850 GHz
Distance de transmission maximale (Sans obstacle gênant ni interférence)	FCC : 8 km (5 mi), CE/MIC : 5 km (3,1 mi) ; SRRC : 5 km (3,1 mi)
Température de fonctionnement	0 à 40 °C (32 à 104 °F)

Batterie	3 950 mAh à 3,83 V
Puissance de l'émetteur (EIRP)	2,4 GHz FCC : ≤ 26 dBm ; CE/MIC : 20 dBm ; SRRC : ≤ 20 dBm 5,8 GHz FCC : ≤ 26 dBm ; CE : 14 dBm ; SRRC : ≤ 26 dBm
Tension de fonctionnement	1 800 mA à 3,83 V (lors du chargement de l'appareil mobile)
Taille des appareils mobiles pris en charge	Épaisseur prise en charge : 6,5 à 8,5 mm, longueur maximale : 160 mm Types de port USB pris en charge : Lightning, Micro-USB (Type B) USB-C
• Chargeur	
Tension	17,6±0,1 V
Puissance nominale	60 W
• Batterie de Vol Intelligente	
Capacité	3 850 mAh
Tension	17,6 V (max.) 15,4 V (standard)
Type de batterie	LiPo 4S
Énergie	59,29 Wh
Poids net	Env. 297 g
Plage de température de chargement	5° à 40 °C (41° à 104 °F)
Puissance de charge max.	80 W
Plage de température d'autochauffage	de 14° à 43° F (de -10° à 6° C)
Durée d'autochauffage	500 s (max.)
Puissance d'autochauffage	55 W (max.)

Pour en savoir plus, consultez le guide de l'utilisateur :
www.dji.com/mavic-2-enterprise

※ Ce contenu peut être modifié sans préavis.

MAVIC est une marque commerciale de DJI.
 Copyright © 2018 DJI Tous droits réservés.

Une création de DJI. Imprimé en Chine.

Velivolo

Il DJI™ MAVIC™ 2 Enterprise è dotato di sistemi di visione omnidirezionali e di sistemi di rilevamento a infrarossi*; presenta una fotocamera gimbal a 3 assi completamente stabilizzata con zoom ottico 2x 24-48 mm equivalente in grado di effettuare riprese video 4K e foto da 12 megapixel che supportano uno zoom 6x FHD. Tecnologie DJI come il rilevamento ostacoli (Obstacle Sensing) e il sistema di pilotaggio assistito (APAS), vi permettono di eseguire riprese complesse senza difficoltà. Caratteristiche aggiuntive come l'AirSense integrato vi rendono consapevoli dello spazio aereo circostante, mentre la protezione con password consente di mantenere un accesso sicuro al velivolo e proteggere i vostri dati. Mavic 2 Enterprise è anche dotato di accessori modulari aggiuntivi M2E quali il riflettore, il lampeggiante e l'altoparlante, che sono stati progettati per diversi utilizzi. Mavic 2 Enterprise vanta una velocità di volo massima di 72 km/h (44,7 mph) e un tempo di volo massimo** di 31 minuti.

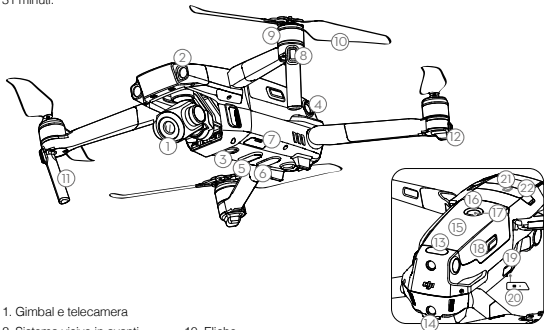

- | | | |
|--|---|--|
| 1. Gimbal e telecamera | 10. Eliche | 18. Fermi della batteria |
| 2. Sistema visivo in avanti | 11. Antenne | 19. Porta USB-C |
| 3. Sistema visivo verso il basso | 12. Indicatore di stato del velivolo | 20. Pulsante di collegamento/
Indicatore di stato del
collegamento |
| 4. Sistema visivo laterale | 13. Sistema di rilevamento a
infrarossi verso l'alto | 21. Porta per gli accessori (per
collegare gli accessori) |
| 5. Sistema di rilevamento a
infrarossi verso il basso | 14. Sistema visivo all'indietro | 22. Coperchio della porta per
gli accessori |
| 6. Luce ausiliaria sulla parte
inferiore | 15. Batteria di volo intelligente | |
| 7. Slot per scheda micro-SD | 16. LED di livello di carica della
batteria | |
| 8. LED anteriori | 17. Pulsante di accensione | |
| 9. Motori | | |

* I sistemi visivi e i sistemi di rilevamento a infrarossi vengono influenzati dalle condizioni circostanti. Per maggiori informazioni, si prega di leggere le limitazioni di responsabilità e direttive sulla sicurezza, il manuale d'uso, e di guardare i video tutorial sul sito web ufficiale di DJI. <http://www.dji.com/mavic-2-enterprise>

** Il tempo massimo di volo è stato testato in assenza di vento e a una velocità costante di 25 km/h (15,5 mph). Questo valore viene fornito soltanto come riferimento.

Dispositivo di controllo remoto

Nel dispositivo di controllo remoto è integrata la tecnologia di trasmissione a lungo raggio OCUSYNC™ 2.0 di DJI che offre un raggio massimo di trasmissione di 8 km (5 miglia) e che visualizza il video dal velivolo all'app DJI Pilot sul dispositivo mobile dell'utente fino a 1080p. Lo schermo LCD di bordo fornisce le informazioni in tempo reale sui dati del velivolo, mentre le levette di comando rimovibili consentono un agevole stoccaggio del dispositivo di controllo remoto. Durata massima di funzionamento: 2 ore e 15 minuti*



Ripiegato

1. Schermo LCD
2. Pulsante di messa in pausa del volo
3. Pulsante 5D
4. Levette di comando rimovibili
5. Pulsante di accensione
6. Antenne
7. Pulsante RTH
8. Alloggiamenti di stoccaggio delle levette di comando
9. Porta video-downlink di riserva (USB)
10. Supporto per dispositivo mobile
11. Commutatore della modalità di volo

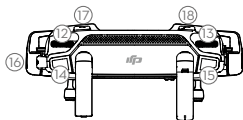
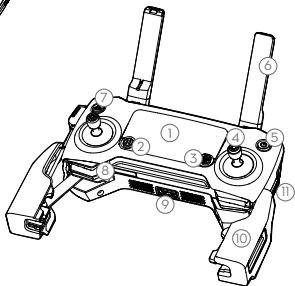

12. Selettore gimbal
13. Selettore di regolazione zoom
14. Pulsante di registrazione
15. Pulsante di messa a fuoco/otturatore
16. Porta video-downlink/alimentazione (micro USB)
17. Pulsante C1 (personalizzabile)
18. Pulsante C2 (personalizzabile)

* Il dispositivo di controllo remoto è in grado di raggiungere la massima distanza di trasmissione (FCC) in una vasta area all'aperto priva di interferenze elettromagnetiche, a un'altitudine di circa 120 m (400 piedi).

Il runtime massimo è testato in ambiente di laboratorio. Questo valore viene fornito soltanto come riferimento.

1. Scaricare l'app DJI Pilot e guardare i video tutorial

Cercare "DJI Pilot" nell'App Store o in Google Play, oppure effettuare la scansione del codice QR qui di seguito per scaricare l'app sul proprio dispositivo mobile.



DJI Pilot

I video tutorial sono disponibili su www.dji.com/mavic-2-enterprise.



Video tutorial



DJI Pilot è compatibile con iOS 10.0 (o versioni successive) o Android 4.4.0 (o versioni successive).

2. Preparazione del velivolo

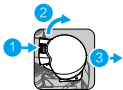

Rimuovere la protezione del gimbal dalla telecamera.



Dispiegare i bracci anteriori.



Dispiegare i bracci posteriori.

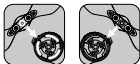

Contrassegnato Non contrassegnato

Far corrispondere le eliche ai motori



Premere con decisione le eliche verso il basso e ruotarle nella direzione di blocco.



Dispiegato



Dispiegare i bracci e le eliche anteriori prima di quelli posteriori. Tutti i bracci e le eliche devono essere dispiegati prima del decollo.

3. Ricarica delle batterie

Utilizzare il caricabatterie in dotazione per caricare completamente la batteria di volo intelligente prima di utilizzarla per la prima volta.

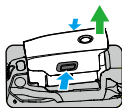

Rimuovere la batteria di volo intelligente



Presenza di alimentazione
100 - 240 V



Tempo di carica:
~1 ora e 30 minuti

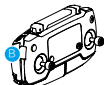

Tempo di carica:
~2 ore e 15 minuti



Rimuovere il cavo del dispositivo di controllo remoto prima di eseguire la ricarica.

* Controllo dei livelli della batteria e accensione/spengimento

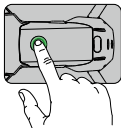

Premere una volta per verificare il livello di carica della batteria.
Premere e tenere premuto per accendere/spengere.

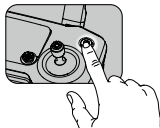

BAT 100 PCT

Premere una volta per verificare il livello di carica della batteria sullo schermo LCD.
Premere una volta, quindi premere e tenere premuto per accendere/spengere il dispositivo di controllo remoto.



Installa la batteria sul velivolo e accendila. Se la temperatura della batteria si abbassa sotto i 6°C, questa inizierà a riscaldarsi automaticamente per mantenere una temperatura tra 8 e 10°C. Consultare il manuale d'uso per maggiori informazioni.

4. Preparazione del dispositivo di controllo remoto

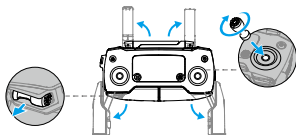

Dispiegare le antenne e le staffe del dispositivo mobile e fissare le levette di comando.



Posizionare una delle estremità del cavo RC all'estremità dell'alloggiamento.

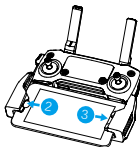

Inserire il dispositivo mobile all'interno delle staffe.



Sistemare le antenne in parallelo tra loro

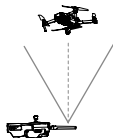
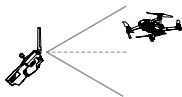

Raggio di trasmissione ottimale



- Accertarsi che le levette di comando siano montate saldamente.
- Il cavo del dispositivo di controllo remoto con il connettore Lightning è montato per impostazione predefinita. Utilizzare il cavo appropriato per il proprio dispositivo mobile per il collegamento del dispositivo di controllo remoto. Se si utilizza un iPad o un tablet, usare la porta USB sul dispositivo di controllo remoto.
- Non utilizzare la porta micro USB e la porta USB contemporaneamente per il collegamento video.

5. Preparazione al decollo



Accendere il dispositivo di controllo remoto



Accendere il velivolo



Lanciare l'app DJI Pilot



Utilizzare il proprio account DJI per attivare il velivolo. L'attivazione richiede una connessione Internet.



Impostare una password per il velivolo nell'app DJI Pilot, per assicurare un accesso sicuro e proteggere i vostri dati durante il volo.

6. Volo

Prima del decollo, assicurarsi che la barra di stato del velivolo nell'app DJI Pilot indichi "Ready to Go".

Ready to Go (GPS)

• Decollo e atterraggio manuali

Combinazione di comandi da levette per avviare/arrestare i motori.



Portare la levetta sinistra (lentamente) verso l'alto per il decollo



Portare la levetta sinistra (lentamente) verso il basso finché non si tocca il suolo
Tenere premuto alcuni secondi per arrestare i motori



I motori possono essere spenti solo a metà volo, quando il sistema di controllo di volo rileva un errore critico.

* Funzionamento del dispositivo di controllo remoto

La modalità predefinita di controllo di volo è "Mode 2". La levetta sinistra controlla l'altitudine e la direzione del velivolo, mentre la levetta destra ne controlla i movimenti in avanti, all'indietro, a sinistra e a destra. Il quadrante del gimbal controlla l'inclinazione della telecamera.

Levetta sinistra



Levetta destra

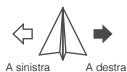

- Impostare sempre un'altitudine RTH adeguata prima del decollo. Quando il velivolo sta tornando al punto iniziale, è consigliabile guidarlo con le leve di comando.
- Premere il volo il pulsante Flight Pause per la frenata di emergenza durante il volo.

* Accessori modulari



Lampeggiante M2E



Riflettore M2E



Altoparlante M2E

7. Fly Safe



Volare in zone aperte

+



Segnale GPS forte

+



Mantenere la linea di visione

+



Volare a un'altitudine inferiore a 120 m (400 piedi)



Evitare di volare al di sopra o in prossimità di ostacoli, folle, linee elettriche ad alta tensione, alberi e specchi d'acqua.

NON utilizzare il velivolo in prossimità di intense sorgenti elettromagnetiche quali linee elettriche e stazioni di base, in quanto tali sorgenti possono influenzare la bussola di bordo.



NON utilizzare il velivolo in condizioni meteorologiche avverse come pioggia, neve, nebbia e venti con velocità superiore a 10 m/s (22 mph).



Mantenere la distanza dalle eliche rotanti e dai motori.



Zona interdetta al volo

Per saperne di più:
<http://fllysafe.dji.com/no-fly>



Per la sicurezza propria e delle altre persone presenti nelle vicinanze, è importante comprendere le linee guida di base del volo. Ricordare di leggere le *Limitazioni di responsabilità e le direttive sulla sicurezza*.

Caratteristiche tecniche

• Velivolo

Peso	905 g
Velocità massima	72 km/h (44,7 mph) in modalità Sport in assenza di vento
Quota massima di funzionamento sopra il livello del mare	6.000 m (19.685 piedi)
Temperatura di funzionamento	Da -10 °C a 40 °C (da 14 °F a 104 °F)
GNSS	GPS + GLONASS
Frequenza di funzionamento	2,4-2,4835 GHz; 5,725-5,850 GHz
Potenza del trasmettitore (EIRP)	2,4 GHz FCC: ≤26 dBm; CE/MIC: ≤20 dBm; SRRC: ≤20 dBm 5,8 GHz FCC: ≤26 dBm; CE: ≤14 dBm; SRRC: ≤26 dBm
Memoria interna	24 GB

• Gimbal

Intervallo controllabile	Beccheggio: da -90° a +30°
--------------------------	----------------------------

• Telecamera

Sensore	CMOS da 1/2.3"; pixel effettivi: 12M
Obiettivo	FOV: circa 83° (24 mm), circa 48° (48 mm) formato equivalente 35 mm: 24-48 mm Apertura: f/2,8 (24 mm) - f/3,8 (48 mm) Messa a fuoco: 0.5 m a ∞
Intervallo ISO	Video: 100 - 3200 Foto: 100-1600 (auto), 100-3200 (manuale)
Velocità dell'otturatore elettronico	8-1/8000 s
Massima dimensione immagine	4000×3000
Modalità fotografia	Scatto singolo Scatti a raffica: 3/5/7 fotogrammi Auto Exposure Bracketing (AEB): 3/5 fotogrammi raggruppati a 0,7 EV bias Intervallo
Modalità di registrazione video	Ultra HD in 4K: 3840×2160 24/25/30p 2,7 K: 2688×1512 24/25/30/48/50/60p FHD: 1.920×1080 24/25/30/48/50/60/120p
Velocità di trasmissione per memorizzazione video	100 Mbps
Fotografie	JPEG, DNG (RAW)
Video	MP4, MOV (MPEG-4 AVC/H.264, HEVC)
Schede SD supportate	microSD Capacità massima: 128 GB (richiesto SpeedGrade 3 UHS-I)

• Dispositivo di controllo remoto

Frequenza di funzionamento	2,4-2,4835 GHz; 5,725-5,850 GHz
Distanza massima di trasmissione (senza ostacoli né interferenze)	FCC: 8 km (5 mi); CE/MIC: 5 km (3,1 mi); SRRC: 5 km (3,1 mi)
Temperatura di funzionamento	Da 0 °C a 40 °C (da 32 °F a 104 °F)

TB50-M200	3950 mAh a 3,83 V
Potenza del trasmettitore (EIRP)	2,4 GHz FCC: ≤26 dBm; CE/MIC: ≤20 dBm; SRRC: ≤20 dBm 5,8 GHz FCC: ≤26 dBm; CE: ≤14 dBm; SRRC: ≤26 dBm
Tensione di funzionamento	1800 mA a 3,83 V (durante la ricarica del dispositivo mobile)
Dimensioni del dispositivo mobile supportato	Spessore supportato: 6,5 - 8,5 mm, Lunghezza massima: 160 mm Tipi di porte USB compatibili: Lightning, Micro USB (Tipo B) USB-C
* Caricatore	
Tensione	17,6±0,1 V
Potenza nominale	60 W
* Batteria di volo intelligente	
Capacità	3850 mAh
Tensione	17,6 V (max) 15,4 V (tipico)
Tipo di batteria	LiPo 4S
Energia	59,29 Wh
Peso netto	Circa 297 g
Intervallo temperatura di carica	Da 5 °C a 40 °C (da 41 °F a 104 °F)
Massima potenza di carica	80 W
Intervallo di temperatura per il riscaldamento automatico	da -10° a 6° C
Durata riscaldamento automatico	500 s (max)
Potenza riscaldamento automatico	55 W (max)

Per ulteriori informazioni, consultare il Manuale utente:
www.dji.com/mavic-2-enterprise

※ Questi contenuti sono soggetti a modifiche senza preavviso.

MAVIC è un marchio registrato di DJI.
 Copyright © 2018 DJI Tutti i diritti riservati.

Progettato da DJI. Stampato in Cina.

Drone

De DJI™ MAVIC™ 2 Enterprise heeft omnidirectionele Vision Systems en infraroodsensorsystemen* en wordt geleverd met een volledig gestabiliseerde 3-assige gimbalcamera met een gelijkwaardige 24-48 mm 2x optische zoomlens die 4K-video's en 12-megapixel-foto's kan vastleggen, met ondersteuning voor maximaal 6x FHD zoom. De voor DJI zo kenmerkende technologieën zoals Obstacle Sensing en het Advanced Pilot Assistance System helpen je om moeiteloos opnamen te maken. Extra functies zoals de geïntegreerde AirSense maken je bewust van het luchtruim om je heen, en de wachtwoordbeveiliging geeft je veilig toegang tot je drone en beschermt je gegevens. De Mavic 2 Enterprise heeft ook opzetbare modulaire accessoires zoals de M2-spotlight, het M2E-baken en de M2E-luidspreker, die speciaal zijn ontwikkeld voor verschillende toepassingen. De Mavic 2 Enterprise kan bogen op een maximale vliegsnelheid van 72 km/u (44,7 mph) en een maximale vliegduur** van 31 minuten.

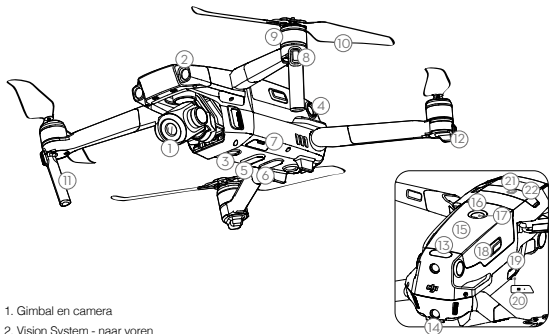

1. Gimbal en camera

2. Vision System - naar voren

3. Vision System - naar beneden

4. Vision System - dwarsrichting

5. Naar beneden gericht
infraroodsensorsysteem

6. Extra lampje onderaan

7. microSD-kaartsleuf

8. LED's voorzijde

9. Motoren

10. Propellers

11. Antennes

12. Statusindicator drone

13. Infraroodsensorsysteem

14. Vision System naar achteren

15. Intelligent Flight Battery

16. Accuniveau-leds

17. Aan-/uitknop

18. Accuaansluitingen

19. USB-C-poort

20. Koppeltoets/
koppelingstatusindicator

21. Uitbreidingspoort (voor het
aansluiten van accessoires)

22. Afdekking uitbreidingspoort

* Het Vision System en infraroodsensorsysteem worden beïnvloed door omgevingsomstandigheden. Lees de disclaimer en veiligheidsrichtlijnen en de gebruikershandleiding en bekijk de instructiefilmpjes op de officiële DJI-website voor meer informatie. <http://www.dji.com/mavic-2-enterprise>

** De maximale vliegduur is getest bij omstandigheden zonder wind en met een constante snelheid van 25 km/u (25,5 mph). Deze waarde geldt alleen ter referentie.

Afstandsbediening

De lange-afstands-transmissietechnologie OCUSYNC™ 2.0 is geïntegreerd in de afstandsbediening van DJI, waardoor deze een maximaal zendbereik van 8 km (5 mijl) biedt en videostreaming van de drone naar de DJI Pilot-app op je mobiele apparaat weergeeft met tot wel 1080p. Een on-board-LCD-scherm biedt real-time-informatie over dronegegevens en door de verwijderbare joysticks kan de afstandsbediening eenvoudiger worden opgeborgen.

Maximale bedrijfstijd: 2 uur en 15 minuten*



Ingeklapt

1. LCD-scherm
2. Vluchtpauzeknop
3. 5D-knop
4. Verwijderbare joysticks
5. Aan/uitknop
6. Antennes
7. RTH-knop
8. Opslagsleuf joysticks
9. Reserve video-downlinkpoort (USB)
10. Klem mobiel apparaat
11. Vluchtmodusshakelaar

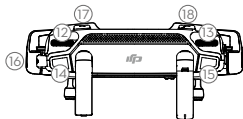
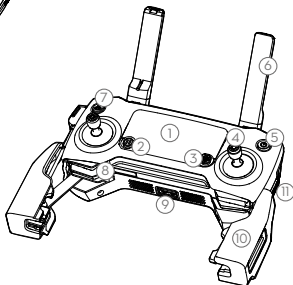

12. Gimbalwiel
13. Instelwiel zoomfunctie
14. Opnameknop
15. Scherpstellers-/opnameknop
16. Video-downlink/aan/uit-knop (micro-USB)
17. C1-knop (aanpasbaar)
18. C2-knop (aanpasbaar)

* De afstandsbediening kan de maximale overdrachtsafstand (FCC) bereiken in een grote open ruimte zonder elektromagnetische interferentie, en op een hoogte van circa 120 meter (400 ft).

De maximale looptijd is getest in een laboratorium. Deze waarde geldt alleen ter referentie.

1. Download de DJI Pilot-app en bekijk de filmpjes met uitleg

Zoek op 'DJI Pilot' in de App Store of Google Play, of scan de onderstaande QR-code om de app te downloaden op je mobiele apparaat.



DJI Pilot

Bekijk de instructiefilmpjes op www.dji.com/mavic-2-enterprise.



Filmpjes met uitleg



DJI Pilot wordt ondersteund door iOS 10.0 (of hoger) of Android 4.4.0 (of hoger).

2. Drone voorbereiden

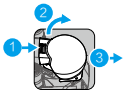

Verwijder de gimbal-afdekking van de camera.



Klap de voorarmen uit.



Klap de achterarmen uit.

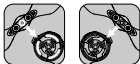

Gemarkeerd Ongemarkeerd
Combineer de juiste propellers met de motoren.



Druk de propellers stevig naar beneden en draai ze in de vergrendelde stand.



Uitgeklapt



Klap de voorarmen en de propellers uit vóór de achterste. Alle armen en propellers moeten uitgeklapt zijn voordat mag worden opgestegen.

3. De accu's opladen

Gebruik de meegeleverde oplader om de Intelligent Battery volledig op te laden vóór het eerste gebruik.

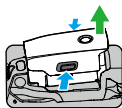

De Intelligent Flight Battery verwijderen

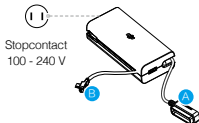

Oplaadtijd:
~1 uur en 30 minuten

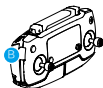

Oplaadtijd:
~2 uur en 15 minuten

 Verwijder vóór het laden de kabel van de afstandsbediening.

* Controleer het laadniveau van de accu en de aan/uit-schakelaar

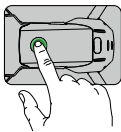

Druk eenmaal op de knop om het accuniveau te controleren.
Druk eenmaal en druk vervolgens opnieuw en houd vast om aan/uit te zetten.

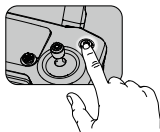

BAT 100 PCT

Druk eenmaal om het accuniveau op het LCD-scherm te controleren.
Druk eenmaal en druk vervolgens opnieuw en houd vast om de afstandsbediening aan/uit te zetten.

 Plaats de accu in de drone en schakel de drone in. Wanneer de accutemperatuur lager wordt dan 6 °C, zal deze automatisch worden opgewarmd tot een temperatuur tussen 8-10 °C. Raadpleeg de gebruikershandleiding voor meer informatie.

4. Voorbereiding van de afstandsbediening

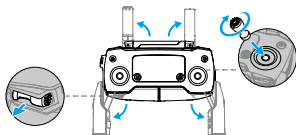

Klap de antennes en de klemmen van het mobiele apparaat uit en breng de joysticks aan.



Sterk



Zwak

Stel de antennes parallel aan elkaar af

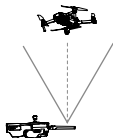
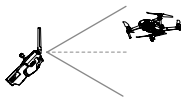

Optimaal zendbereik

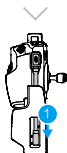

Plaats één uiteinde van de RC-kabel op het sleufeinde.

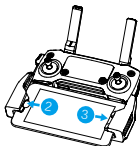

Plaats je mobiele apparaat in de klemmen.

- ⚠️ • Zorg dat de joysticks stevig zijn aangebracht.
- De kabel van de afstandsbediening met de Lightning Connector is standaard aangebracht. Gebruik de juiste kabel om je mobiele apparaat op de afstandsbediening aan te sluiten. Wanneer je een iPad of tablet gebruikt, gebruik dan de USB-poort op de afstandsbediening.
- Gebruik de micro-USB- en de USB-poorten tegelijkertijd om video te koppelen.

5. Voorbereiding voor opstijgen



Schakel de afstandsbediening in



Schakel het luchtvaartuig in



Start DJI Pilot



Internet

Gebruik je DJI-account om de drone te activeren. Activering vereist een internetverbinding.



Stel een wachtwoord in voor de drone in de DJI Pilot-app om veilige toegang te waarborgen en je boordgegevens te beschermen.

6. Vlucht

Zorg er vóór het opstijgen voor dat de statusbalk van de drone in de DJI Pilot-app 'Ready to Go' aangeeft.

Ready to Go (GPS)

• Handmatig opstijgen/landen

Combination Stick Command (CSC) voor het starten/stoppen van de motoren



OF



Linkerstick omhoog (langzaam) om op te stijgen



Linkerjoystick omlaag (langzaam) totdat u de grond raakt
Wacht enkele seconden om de motoren uit te schakelen



De motoren kunnen gedurende de vlucht alleen worden stopgezet wanneer de vluchtcontroller een kritieke fout detecteert.

* Besturing met de afstandsbediening

De standaard vluchtregeling staat bekend als modus 2. Met de linkerjoystick regel je de hoogte en koers, terwijl je met de rechterjoystick vooruit, achteruit, naar links en rechts kunt bewegen. Met de gimbal regel je de kanteling van de camera.

Linkerjoystick



Omhoog



Omlaag



Linksaf



Rechtsaf

Rechterjoystick



Vooruit



Achteruit



Links



Rechts



- Stel altijd een passende RTH-hoogte in vóór het opstijgen. Als het luchtvaartuig terugkeert naar de basis, dien je het te begeleiden met de joysticks.
- Druk op de Flight Pause-knop om tijdens de vlucht een noodstop uit te voeren.

* Modulaire accessoires



M2E Baken



M2E Spotlicht



M2E Luidspreker

7. Vlieg veilig



Vlieg in open gebieden



Krachtig GPS-signaal



Houd je drone in het zicht



Vlieg lager dan 120 m (400 feet)



Vermijd vliegen boven of nabij obstakels, drukte, hoogspanningsleidingen, bomen of water.

Vlieg NIET in de buurt van sterke elektromagnetische bronnen zoals elektriciteitsleidingen en basisstations, daardoor kan het ingebouwde kompas ongunstig worden beïnvloed.



Gebruik de drone NIET bij ongunstige weersomstandigheden zoals regen, sneeuw, mist en bij windsnelheden van meer dan 10 m/s of 22 mph.



Blijf uit de buurt van de roterende propellers en motoren.



No-fly zone

Meer informatie vind je op: <http://fllysafe.dji.com/no-fly>



Het is belangrijk de basisvluchtrichtlijnen te begrijpen voor je veiligheid en die van je medemens. Vergeet niet de **disclaimer en veiligheidsrichtlijnen te lezen**.

Specificaties

• Drone

Gewicht	905 g
Max. snelheid	72 km/u (44,7 mph) in de sportmodus zonder wind
Max. servicehoogte boven zeeniveau	6000 m (19.685 ft)
Bedrijfstemperatuur	-10 °C tot 40 °C (14 °F tot 104 °F)
GNSS	GPS + GLONASS
Bedrijfsfrequentie	2,4-2,4835 GHz; 5,725-5,850 GHz
Zendervermogen (EIRP)	2,4 GHz FCC: ≤ 26 dBm; CE/MIC: ≤ 20 dBm; SRRC: ≤ 20 dBm 5,8 GHz FCC: ≤ 26 dBm; CE: ≤ 14 dBm; SRRC: ≤ 26 dBm
Interne opslag	24 GB

• Gimbal

Regelbaar bereik	Helling: -90° tot +30°
------------------	------------------------

• Camera

Sensor	1/2.3"-inch CMOS, effectieve pixels: 12M
Lens	FOV: ca. 83° (24 mm), ca. 48° (48 mm) 35 mm equivalent: 24-48 mm Diafragma: f/2,8 (24 mm) - f/3,8 (48 mm) Focus: 0.5 m tot ∞
ISO-bereik	Video: 100-3200 Foto: 100-1600 (auto); 100-3200 (handmatig)
Elektronische sluitertijd	8-1/8000 s
Maximale beeldgrootte	4000x3000
Fotografie modi stilbeelden	Enkele opname Serieopnamen: 3/5/7 frames Auto Exposure Bracketing (AEB): 3/5 bracketed frames bij 0,7 EV Bias Interval
Video-opnamemodi	4K Ultra HD: 3840x2160 24/25/30p 2,7 K: 2688x1512 24/25/30/48/50/60p FHD: 1920x1080 24/25/30/48/50/60/120p
Bitrate video-opslag	100 Mbps
Foto	JPEG, DNG (RAW)
Video	MP4, MOV (MPEG-4 AVC/H.264, HEVC)
Ondersteunde SD-kaarten	microSD Max. capaciteit: 128 GB (UHS-I Speed Grade 3-rating vereist)

• Afstandsbediening

Bedrijfsfrequentie	2,4-2,4835 GHz; 5,725-5,850 GHz
Max. zendafstand (Vrij van obstakels en interferentie)	FCC: 8 km (5 mi); CE/MIC: 5 km (3,1 mi); SRRC: 5 km (3,1 mi)
Bedrijfstemperatuur	0 °C tot 40 °C (32 °F tot 104 °F)

Battery	3950 mAh bij 3,83 V
Zendervermogen (EIRP)	2,4 GHz FCC: ≤ 26 dBm; CE/MIC: ≤ 20 dBm; SRRC: ≤ 20 dBm 5,8 GHz FCC: ≤ 26 dBm; CE: ≤ 14 dBm; SRRC: ≤ 26 dBm
Bedrijfsspanning	1800 mAh bij 3,83 V (bij opladen van het mobiele apparaat)
Ondersteunde grootte mobiel apparaat	Ondersteunde dikte: 6,5 - 8,5 mm, Max. lengte: 160 mm Ondersteunde USB-poorttypen: Lightning, micro-USB (Type-B) USB-C
• Oplader	
Spanning	17,6±0,1 V
Nominaal vermogen	60 W
• Intelligent Flight Battery	
Capaciteit	3850 mAh
Spanning	17,6 V (max) 15.4 V (typisch)
Accutype	LiPo 4S
Vermogen	59,29 Wh
Netto gewicht	Ongeveer 297 g
Bereik oplaadtemperatuur	5 °C tot 40 °C (41 °F tot 104 °F)
Max. oplaadvermogen	80 W
Temperatuurbereik automatische verwarming	-10 °C tot 6 °C (14 °F tot 43 °F)
Tijdsduur automatische verwarming	500 s. (max.)
Vermogen automatische verwarming	55 W (max.)

Lees de gebruikershandleiding voor meer informatie:

www.dji.com/mavic-2-enterprise

※ Deze inhoud is onderhevig aan wijzigingen zonder voorafgaande kennisgeving.

MAVIC is een handelsmerk van DJI.

Copyright © 2018 DJI Alle rechten voorbehouden.

Ontworpen door DJI. Gedrukt in China.

Aeronave

O DJI™ MAVIC™ 2 Enterprise possui sistemas de visão omnidirecional e sistemas de detecção de infravermelhos*, inclui uma câmara com suspensão cardã de 3 eixos totalmente estabilizada, com uma objetiva de zoom ótico de 2x equivalente a 24-48 mm, capaz de filmar vídeos a 4K e tirar fotografias de 12 megapixels, que suportam até 6x zoom FHD. As tecnologias exclusivas da DJI, como o sistema de detecção de obstáculos e o sistema avançado de assistência ao piloto, ajudam a captar imagens complexas com facilidade. Entre as funcionalidades adicionais, o AirSense incorporado permite que tenha uma maior percepção do espaço aéreo circundante, enquanto a proteção de palavra-passe o ajuda a manter o acesso seguro à aeronave e a proteger os seus dados. O Mavic 2 Enterprise também dispõe de acessórios modulares que podem ser facilmente fixados, como o Foco M2E, o Farol M2E e o Altifalante M2E, todos eles concebidos para várias aplicações. O Mavic 2 Enterprise conta com uma velocidade de voo máxima de 72 km/h (44,7 mi/h) e um tempo de voo máximo** de 31 minutos.

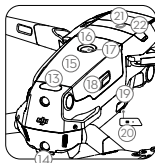
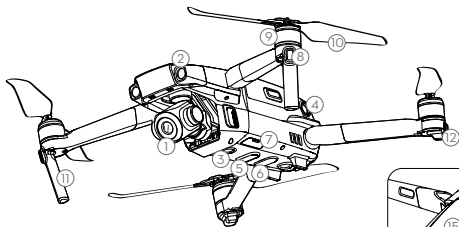

- | | |
|---|---|
| 1. Suspensão cardã e câmara | 10. Hélices |
| 2. Sistema de visão para a frente | 11. Antenas |
| 3. Sistema de visão para baixo | 12. Indicador de estado da aeronave |
| 4. Sistema de visão lateral | 13. Sistema de detecção de infravermelhos para cima |
| 5. Sistema de detecção de infravermelhos para baixo | 14. Sistema de visão para trás |
| 6. Luz auxiliar inferior | 15. Bateria de voo inteligente |
| 7. Ranhura para cartão microSD | 16. LED de nível da bateria |
| 8. LED frontais | 17. Botão de alimentação |
| 9. Motores | |

- | |
|---|
| 18. Fivelas da bateria |
| 19. Porta USB-C |
| 20. Botão de ligação/Indicador de estado da ligação |
| 21. Porta alargada (para ligar acessórios) |
| 22. Tampa da porta alargada |

* Os Sistemas de visão e os Sistemas de detecção de infravermelhos são afetados pelas condições ambiente.

Consulte a Declaração de exoneração de responsabilidade, as Diretrizes de segurança e o Manual do utilizador e assista aos tutoriais de vídeo no Website oficial da DJI para saber mais.

<http://www.dji.com/mavic-2-enterprise>

** O tempo máximo de voo foi testado num ambiente sem vento e a uma velocidade de voo constante de 25 km/h (15,5 mi/h). Este valor serve meramente como referência.

Telecomando

A tecnologia de transmissão de longo alcance OCUSYNC™ 2.0 da DJI está incorporada no telecomando, oferecendo um alcance máximo de transmissão de 8 km (5 mi) e enviando vídeo da aeronave para a aplicação DJI Pilot no seu dispositivo móvel até 1080p. O ecrã LCD incorporado fornece informações em tempo real dos dados da aeronave e os manipuladores de controlo amovíveis tornam o telecomando mais fácil de guardar.

Tempo máximo de funcionamento: 2 horas e 15 minutos*



Dobrado

1. Ecrã LCD
2. Botão de pausa do voo
3. Botão 5D
4. Manipulos de controlo amovíveis
5. Botão de alimentação
6. Antenas
7. Botão para voltar à posição inicial (RTH)
8. Ranhura para armazenamento dos manipuladores de controlo
9. Porta de reserva para ligação de vídeo (USB)
10. Grampo para dispositivo móvel

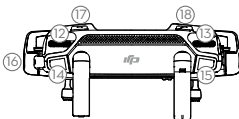
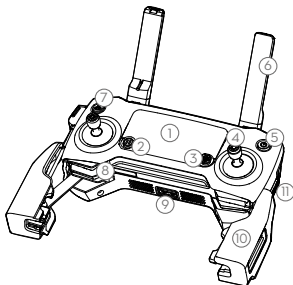

11. Interruptor de modo de voo
12. Botão da suspensão cardã
13. Seletor de ajuste do zoom
14. Botão de gravação
15. Botão de focagem/obturador
16. Porta de alimentação/ligação de vídeo (micro USB)
17. Botão C1 (personalizável)
18. Botão C2 (personalizável)

* O telecomando pode alcançar a sua distância máxima de transmissão (FCC) numa área ampla e aberta, sem interferência eletromagnética, a uma altitude de cerca de 120 m (400 pés).

O tempo máximo de funcionamento é testado em ambiente de laboratório. Este valor serve meramente como referência.

1. Transferir a aplicação DJI Pilot e ver os vídeos tutoriais

Pesquise "DJI Pilot" na App Store ou no Google Play, ou leia o código QR abaixo para transferir a aplicação para o seu dispositivo móvel.



DJI Pilot

Assista aos tutoriais de vídeo em www.dji.com/mavic-2-enterprise.



Vídeos tutoriais



A DJI Pilot é compatível com iOS 10.0 (ou posterior) e Android 4.4.0 (ou posterior).

2. Preparar a aeronave

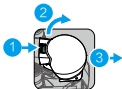

Retire a cobertura da suspensão cardã da câmara.



Desdobre os braços dianteiros.



Desdobre os braços traseiros.

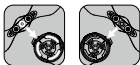

Com marcas Sem marcas

Faça corresponder as hélices aos motores.



Pressione as hélices firmemente para baixo e rode na direção de bloqueio.



Desdobrados



Desdobre os braços dianteiros e as hélices antes dos traseiros. Todos os braços e hélices têm de ser desdobrados antes de descolar.

3. Carregamento das baterias

Utilize o carregador fornecido para carregar completamente a bateria de voo inteligente antes da primeira utilização.

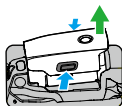

Remova a bateria de voo inteligente

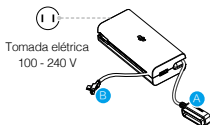

Tomada elétrica
100 - 240 V



Tempo de carregamento:
~1 hora e 30 minutos

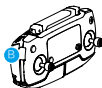

Tempo de carregamento:
~2 horas e 15 minutos

 Retire o cabo do telecommando antes de carregar.

* Verificar os níveis da bateria e ligar/desligar

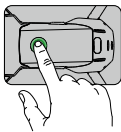

Prima uma vez para verificar o nível da bateria. Prima e, em seguida, prima e mantenha premido para ligar/desligar.

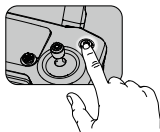

BAT 100 PCT

Prima uma vez para verificar o nível da bateria no ecrã LCD.

Prima uma vez e, em seguida, prima e mantenha premido para ligar/desligar o telecommando.

 Instale a bateria na aeronave e ligue-a. Quando a temperatura da bateria for inferior a 6 °C, a mesma vai aquecer automaticamente para manter uma temperatura entre 8 e 10 °C. Consulte o Manual do utilizador para obter mais informações.

4. Preparar o telecomando

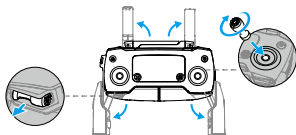

Desdobre as antenas e as braçadeiras para o dispositivo móvel e monte os manipuladores de controlo.



Insira uma ponta do cabo RC até ao final da ranhura.

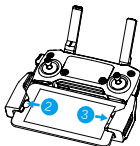

Fixe o seu dispositivo móvel entre as braçadeiras.



Coloque as antenas paralelamente uma à outra

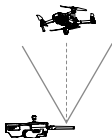
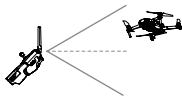

Alcance de transmissão ideal



- Certifique-se de que os manipuladores de controlo estão firmemente montados.
- O cabo do telecomando com o conector Lightning está montado por predefinição. Utilize o cabo adequado para ligar o seu dispositivo móvel ao telecomando. Quando utilizar um iPad ou um tablet, utilize a porta USB do telecomando.
- Não utilize portas micro USB e USB em simultâneo para a ligação de vídeo.

5. Preparar a descolagem



Ligue o telecomando



Ligue a aeronave



Inicie a DJI Pilot



Utilize a sua conta DJI para ativar a aeronave. A ativação requer uma ligação à Internet.



Defina uma palavra-passe para a aeronave na aplicação DJI Pilot para garantir o acesso seguro à mesma e para proteger os seus dados a bordo.

6. Voo

Antes de descolar, assegure-se de que a barra de estado da aeronave na aplicação DJI Pilot indica "Ready to Go".

Ready to Go (GPS)

• Descolagem/Aterragem manual

Comando de manipuladores combinados para ligar/desligar os motores



OU



Desloque lentamente o manipulador esquerdo para cima para descolar



Desloque lentamente o manipulador esquerdo para baixo até que a aeronave toque no solo. Mantenha premido durante alguns segundos para parar os motores.



Os motores só podem ser parados em pleno voo quando o controlador deteta um erro crítico.

* Operação do telecomando

O controlo de voo predefinido é conhecido como Modo 2. O manípulo esquerdo controla a altitude e o rumo da aeronave e o manípulo direito controla os movimentos para a frente, para trás, para a esquerda e para a direita. O botão da suspensão cardã controla a inclinação da câmara.

Manípulo esquerdo

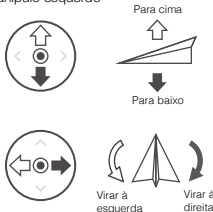

Manípulo direito

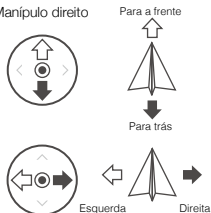

- Defina sempre uma altitude RTH adequada antes da decolagem. Quando a aeronave está a voltar ao ponto inicial, deverá dirigi-la com os manípulos de controlo.
- Prima o botão de pausa do voo para travagens de emergência durante o voo.

* Acessórios modulares



Farol M2E



Foco M2E



Altifalante M2E

7. Voar com segurança



Voar em áreas abertas

+



Sinal de GPS forte

+



Manter a linha de visão

+



Voar abaixo dos 120 m (400 pés)



Evite voar por cima ou perto de obstáculos, multidões, linhas elétricas de alta tensão, árvores e massas de água.

NÃO voe próximo de fontes eletromagnéticas fortes, tais como linhas de alta tensão e estações de rede móvel, pois estas podem afetar a bússola integrada.



NÃO utilize a aeronave em condições atmosféricas adversas, tais como chuva, neve, nevoeiro e ventos com velocidades superiores a 10 m/s ou 35,4 km/h.



Mantenha-se afastado das hélices e dos motores em rotação.



Zona de exclusão aérea

Saiba mais em:
<http://flysafe.dji.com/no-fly>



É importante compreender as diretrizes básicas de voo para a segurança do utilizador e dos que o rodeiam. Não se esqueça de ler a **Declaração de exoneração de responsabilidade e as diretrizes de segurança**.

Características técnicas

• Aeronave

Peso	905 g
Velocidade máxima	72 km/h (44,7 mi/h) no modo desportivo sem vento
Limite de funcionamento máximo acima do nível do mar	6000 m (19 685 pés)
Temperatura de funcionamento	14 °F a 104 °F (-10 °C a 40 °C)
GNSS	GPS + GLONASS
Frequência de funcionamento	2,4 - 2,4835 GHz; 5,725 - 5,850 GHz
Potência do transmissor (EIRP)	2,4 GHz FCC: ≤26 dBm; CE/MIC: ≤20 dBm; SRRC: ≤20 dBm 5,8 GHz FCC: ≤26 dBm; CE: ≤14 dBm; SRRC: ≤26 dBm
Armazenamento interno	24 GB

• Suspensão cardã

Amplitude controlável	Inclinação: -90° a +30°
-----------------------	-------------------------

• Câmara

Sensor	CMOS de 1/2.3"; píxeis reais: 12M
Lente	FOV: approx. 83° (24 mm), approx. 48° (48 mm) Equivalente ao formato de 35 mm: 24-48 mm Abertura: f/2.8 (24 mm) - f/3.8 (48 mm) Focagem: 0.5 m a ∞
Gama ISO	Vídeo: 100-3200 Fotografia: 100-1600 (auto); 100-3200 (manual)
Velocidade do obturador eletrônico	8-1/8000 s
Tamanho máximo da imagem	4000×3000
Modos de fotografia	Disparo único Disparos contínuos: 3/5/7 fotografias Variação da exposição automática (AEB): 3/5 fotografias com variação a 0,7 EV Intervalo
Modos de gravação de vídeo	4K Ultra HD: 3840 × 2160, 24/25/30p 2,7K: 2688 × 1512, 24/25/30/48/50/60p FHD: 1920×1080 24/25/30/48/50/60/120p
Taxa de bits de armazenamento de vídeo	100 Mbps
Fotografia	JPEG, DNG (RAW)
Vídeo	MP4, MOV (MPEG-4 AVC/H.264, HEVC)
Cartões SD compatíveis	microSD Capacidade máxima: 128 GB (classificação necessária: UHS-I Speed Grade 3)

• Telecomando

Frequência de funcionamento	2,4 - 2,4835 GHz; 5,725 - 5,850 GHz
Distância máxima de transmissão (desobstruído e sem interferências)	FCC: 8 km (5 mi), CE/MIC: 5 km (3,1 mi); SRRC: 5 km (3,1 mi)

Temperatura de funcionamento	0 °C a 40 °C (32 °F a 104 °F)
Bateria	3950 mAh a 3,83 V
Potência do transmissor (EIRP)	2,4 GHz FCC: ≤26 dBm; CE/MIC: ≤20 dBm; SRRC: ≤20 dBm 5,8 GHz FCC: ≤26 dBm; CE: ≤14 dBm; SRRC: ≤26 dBm
Tensão de funcionamento	1800 mA a 3,83 V (ao carregar o dispositivo móvel)
Dimensões dos dispositivos móveis suportados	Espessura suportada: 6,5 - 8,5 mm, Comprimento máximo: 160 mm Tipos de portas USB suportados: Lightning, Micro USB (Type-B) USB-C
* Carregador	
Tensão	17,6 ± 0,1 V
Potência nominal	60 W
* Bateria de voo inteligente	
Capacidade	3850 mAh
Tensão	17,6 V (máx.) 15,4 V (típico)
Tipo de bateria	LiPo 4S
Energia	59,29 Wh
Peso líquido	Aprox. 297 g
Intervalo de temperatura de carregamento	5 °C a 40 °C (41 °F a 104 °F)
Potência máx. de carregamento	80 W
Intervalo de temperatura de aquecimento automático	-10 a 6 °C (14 a 43 °F)
Tempo de aquecimento automático	500 segundos (máx.)
Potência de aquecimento automático	55 W (máx.)

Para mais informações, consulte o manual do utilizador:
www.dji.com/mavic-2-enterprise

※ Este conteúdo está sujeito a alterações sem aviso prévio.

MAVIC é uma marca comercial da DJI.
Copyright © 2018 DJI Todos os direitos reservados.

Criado pela DJI. Impresso na China.

Aeronave

O DJI™ MAVIC™ 2 Enterprise possui Sistemas de Visão Omnidirecionais e Sistemas de Detecção de Infravermelho*, acompanhando uma câmera totalmente estável com estabilizador triaxial, lente de zoom ótico de 2x equivalente a 24-48 mm para gravação de vídeos em 4K e para tirar fotos de 12 megapixels compatíveis com zoom até 6x em FHD. As tecnologias características da DJI, como a Detecção de Obstáculos e o sistema APAS (Advanced Pilot Assistance System), permitem capturar as mais complexas imagens com mínimo esforço. Recursos adicionais como o AirSense integrado fazem com que tome conhecimento do ambiente adjacente, e a proteção de senha permite que mantenha um acesso seguro à aeronave e protege seus dados. O Mavic 2 Enterprise possui ainda acessórios modulares removíveis, como o Holofote M2E, o Farol M2E e o Alto-falante M2E, criados com o propósito de servir a múltiplos usos. O Mavic 2 Enterprise alcança uma velocidade máxima de voo de 72 km/h (44,7 mph) e um tempo de voo máximo** de 31 minutos.

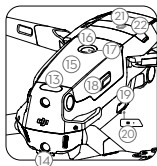
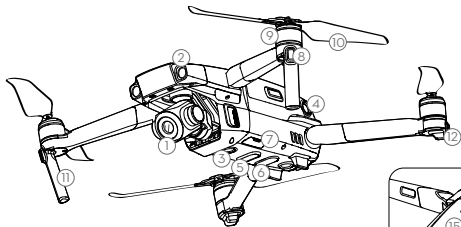

- | | | |
|---|---|---|
| 1. Estabilizador e Câmera | 10. Hélices | 18. Fivelas da bateria |
| 2. Sistema de visão frontal | 11. Antenas | 19. Porta USB-C |
| 3. Sistema de visão inferior | 12. Indicador de status da aeronave | 20. Botão Link/Indicador de status da câmera |
| 4. Sistema de visão lateral | 13. Sistema de Detecção Infravermelho voltado para cima | 21. Porta de extensão (para acoplar acessórios) |
| 5. Sistema de Detecção Infravermelho voltado para baixo | 14. Sistema de visão traseiro | 22. Tampa da porta de extensão |
| 6. Luz inferior auxiliar | 15. Bateria de Voo Inteligente | |
| 7. Slot de cartão microSD | 16. LEDs de nível de bateria | |
| 8. LEDs dianteiros | 17. Botão liga/desliga | |
| 9. Motores | | |

* Os Vision Systems e os Sistemas de Detecção Infravermelho são afetados pelas condições circundantes. Leia a Isenção de Responsabilidade, as Diretrizes de Segurança, o Manual do Usuário e assista aos vídeos tutoriais no site oficial da DJI para saber mais. <http://www.dji.com/mavic-2-enterprise>

** O tempo de voo máximo foi testado em condição de vento zero à velocidade constante de 15,5 mph (25 km/h). Esse valor é meramente para referência.

Controle remoto

A tecnologia aprimorada OCUSYNC™ 2.0 da DJI é integrada ao controle remoto e oferece um alcance máximo de transmissão de 8 km (5 mi) e envia os vídeos capturados pela aeronave ao app DJI Pilot em seu dispositivo móvel com até 1080p. Uma tela LCD de bordo fornece informações de dados da aeronave em tempo real. Os joysticks desmontáveis facilitam na hora de guardar o controle remoto.

Tempo máximo de execução: 2 horas e 15 minutos*



Dobrado

1. Tela LCD
2. Botão de pausa do voo
3. Botão 5D
4. Joysticks desmontáveis
5. Botão liga/desliga
6. Antenas
7. Botão RTH
8. Nicho de armazenamento dos joysticks
9. Porta reserva de downlink de vídeo (USB)
10. Suporte de dispositivo móvel
11. Interruptor do modo de voo

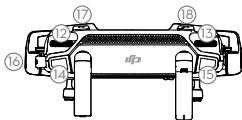
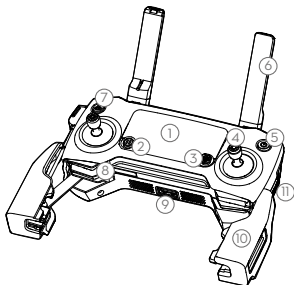

12. Botão Gimbal
13. Botão de ajuste do zoom
14. Botão Record
15. Botão de foco/obturador
16. Porta de downlink de vídeo/alimentação (microUSB)
17. Botão C1 (personalizável)
18. Botão C2 (personalizável)

* O controle remoto é capaz de atingir sua distância máxima de transmissão em uma área aberta sem interferência eletromagnética e a uma altitude de aproximadamente 400 pés (120 metros).

O tempo de uso máximo é testado em um ambiente de laboratório. Esse valor é meramente para referência.

1. Download do aplicativo DJI Pilot e vídeos de tutorial

Pesquise "DJI Pilot" na App Store ou Google Play, ou digitalize o código QR abaixo para fazer download do aplicativo no seu dispositivo móvel.



DJI Pilot

Assista aos vídeos tutoriais em www.dji.com/mavic-2-enterprise.



Vídeos tutoriais



O DJI Pilot é compatível com o iOS 10.0 (ou posterior) ou Android 4.4.0 (ou posterior).

2. Preparo da aeronave

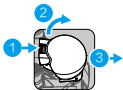

Remova o grampo do estabilizador da câmera.



Desdobre os braços frontais.



Desdobre os braços traseiros.

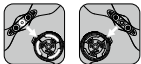

Corresponda as hélices aos motores.



Pressione as hélices firmemente para baixo e gire-a na direção de travamento.



Desdobrados



Desdobre os braços e as hélices frontais antes dos traseiros. Todos os braços e hélices devem ser desdobrados antes da decolagem.

3. Carga das baterias

Use o carregador fornecido para carregar totalmente a Bateria de Voo Inteligente antes de usar pela primeira vez.

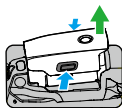

Remova a Bateria de Voo Inteligente

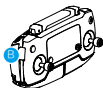
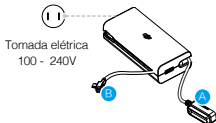

Tempo de carregamento:
~1 hora e 30 minutos

Tempo de carregamento:
~2 horas e 15 minutos



Remova o cabo do controle remoto antes de carregar.

* Verificação dos níveis da bateria e ligar/desligar

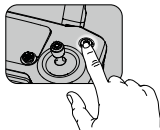
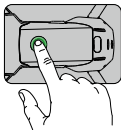

BAT 100 PCT

Pressione uma vez para verificar o nível da bateria.

Pressione uma vez; em seguida, novamente e segure para ligar/desligar.

Pressione uma vez para verificar o nível da bateria na tela LCD.

Pressione uma vez e, em seguida, pressione e segure novamente para ligar/desligar o controle remoto.



Instale a bateria na aeronave e ligue-a. Uma vez que a temperatura da bateria for inferior a 6° C, entrará em aquecimento automático para manter uma temperatura entre 8° e 10° C. Confira o Manual do Usuário para obter mais detalhes.

4. Preparo do controle remoto

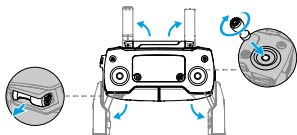

Desdobre as antenas e as braçadeiras do dispositivo móvel, e instale os joysticks.



Conecte uma das pontas do cabo RC à extremidade do slot no controle remoto.

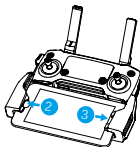

Conecte seu dispositivo móvel às braçadeiras.



Forte



Fraco

Posicione as antenas paralelamente

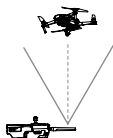
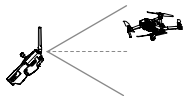

Faixa de transmissão ideal

- ⚠ Confira se os joysticks estão colocados firmemente.
- O cabo do controle remoto vem conectado ao conector Lightning como padrão de fábrica. Use o cabo apropriado para seu dispositivo móvel para conectar o controle Remoto. Ao usar um iPad ou tablet, use a porta USB no controle remoto.
- Não utilize as portas Micro USB e USB simultaneamente para fazer a ligação do vídeo.

5. Preparação para a decolagem



Ligue o controle remoto.



Ligue a aeronave.



Inicie o DJI Pilot



Internet

Use sua conta DJI para ativar a aeronave. A ativação requer uma conexão com a internet.



Defina uma senha para a aeronave no aplicativo DJI Pilot para garantir um acesso seguro e proteger seus dados a bordo.

6. Voo

Antes da decolagem, verifique se a barra de status da aeronave no aplicativo DJI Pilot exibe "Ready to Go".

Ready to Go (GPS)

*Decolagem e pouso manuais

Combination Stick Command para ligar/
desligar os motores



Joystick esquerdo para cima (lentamente) para decolar



Mova (lentamente) o joystick para baixo até tocar o chão
Segure por alguns segundos para parar os motores



Os motores podem ser parados em pleno voo apenas quando o controlador de voo detectar um erro crítico.

* Operação do controle remoto

O padrão de controle de voo é conhecido como Modo 2. O joystick esquerdo controla a altitude e a direção da aeronave, enquanto o joystick direito controla os movimentos para frente, para trás, para a esquerda e para a direita. O botão giratório do gimbal controla a inclinação da câmera.

Joystick esquerdo

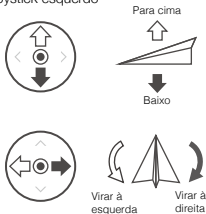

Joystick direito

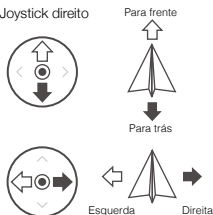

- Configure sempre uma altitude RTH adequada antes de decolar. Quando a aeronave estiver retornando ao Home Point, você deverá orientá-la com os joysticks.
- Pressione o botão Flight Pause para pausas de emergência durante o voo.

* Acessórios modulares



Farol M2E



Holofote M2E



Alto-falante M2E

7. Voe com segurança



Voe em espaços abertos



Sinal de GPS forte



Mantenha o campo de visão



Voe abaixo de 120 m (400 pés)



Evite voar acima de ou próximo de obstáculos, multidões, linhas de alta tensão, árvores e corpos d'água.

NÃO voe próximo a fontes eletromagnéticas fortes, como linhas de energia e estações rádio base, pois isso pode afetar a bússola embarcada.



Não use a aeronave em condições climáticas adversas como chuva, neve, neblina e velocidades do vento acima de 10 m/s ou 22 mph.



Fique longe das hélices giratórias e dos motores.



Zona de exclusão aérea

Saiba mais em:
<http://fllysafe.dji.com/no-fly>



É importante que você compreenda as diretrizes básicas de voo, tanto para a sua proteção como para a segurança das pessoas à sua volta. Não se esqueça de ler a *isenção e as Diretrizes de segurança*.

Especificações

• Aeronave

Peso	905 g
Velocidade máx.	44,7 mph (72 km/h) no modo Sport, sem vento
Teto máximo de serviço acima do nível do mar	6.000 metros (19.685 pés)
Temperatura operacional	-10° a 40° C (14° a 104° F)
GNSS	GPS + GLONASS
Frequência de funcionamento	2,4 – 2,4835 GHz; 5,725 – 5,850 GHz
Potência do transmissor (EIRP)	2,4 GHz FCC: ≤ 26 dBm; CE/MIC: ≤ 20 dBm; SRRC: ≤ 20 dBm 5,8 GHz FCC: ≤ 26 dBm; CE: ≤ 14 dBm; SRRC: ≤ 26 dBm
Armazenamento interno	24 GB

• Estabilizador

Amplitude controlável	Inclinação: -90° a +30°
-----------------------	-------------------------

• Câmera

Sensor	CMOS de 1/2.3"; pixels efetivos: 12M
Objetiva	FOV: approx. 83° (24 mm), approx. 48° (48 mm) Formato de 35 mm equivalente: 24-48 mm Abertura: f/2.8 (24 mm) - f/3.8 (48 mm) Focagem: 0.5 m a ∞
Gama ISO	Vídeo: 100-3200 Foto: 100-1600 (automático); 100-3200 (manual)
Velocidade do obturador eletrônico	8-1/8000 s
Tamanho máximo da imagem	4000×3000
Modos de fotografia	Disparo único Disparo sequencial: 3/5/7 quadros Variação da exposição automática (AEB): 3/5 quadros com bracketing em variação de 0,7 EV Intervalo
Modos de gravação de vídeo	4K Ultra HD: 3840×2160 24/25/30p 2,7K: 2688×1512 24/25/30/48/50/60p FHD: 1920×1080 24/25/30/48/50/60/120p
Taxa de bits para armazenamento de vídeo	100 Mbps
Foto	JPEG, DNG (RAW)
Vídeo	MP4, MOV (MPEG-4 AVC/H.264, HEVC)
Suporta cartões SD	microSD Capacidade máxima: 128 GB (necessário classificação de velocidade UHS-I Grau 3)

• Controle remoto

Frequência de funcionamento	2,4 – 2,4835 GHz; 5,725 – 5,850 GHz
Distância máxima de transmissão (sem obstrução, livre de interferências)	FCC: 8 km (5 mi); CE/MIC: 5 km (3,1 mi); SRRC: 5 km (3,1 mi)

Temperatura operacional	0° a 40° C (32° a 104° F)
Bateria	3950 mAh a 3,83 V
Potência do transmissor (EIRP)	2,4 GHz FCC: ≤ 26 dBm; CE/MIC: ≤ 20 dBm; SRRC: ≤ 20 dBm 5,8 GHz FCC: ≤ 26 dBm; CE: ≤ 14 dBm; SRRC: ≤ 26 dBm
Tensão de operação	1800 mA @ 3,83 V (ao carregar o dispositivo móvel)
Tamanhos de dispositivos móveis suportados	Espessura suportada: 6,5 - 8,5 mm, comprimento máximo: 160 mm Tipos de portas USB suportadas: Lightning, Micro USB (Tipo B) USB-C
* Carregador	
Tensão	17,6±0,1 V
Potência nominal	60 W
* Bateria de Voo Inteligente	
Capacidade	3850 mAh
Tensão	17,6 V (máx) 15,4 V (típica)
Tipo de bateria	LiPo 4S
Energia	59,29 Wh
Peso líquido	Aprox. 297 g
Faixa de temperatura de carregamento	5° a 40° C (41° a 104° F)
Potência máx. de carga	80 W
Alcance da temperatura de aquecimento automático	-10° a 6 °C
Duração do aquecimento automático	500 s (máx.)
Carga do aquecimento automático	55 W (máx.)

Para mais informações, consulte o manual do usuário:
www.dji.com/mavic-2-enterprise

※ Este conteúdo está sujeito a alterações sem prévio aviso.

MAVIC é uma marca comercial da DJI.
Copyright © 2018 Todos os direitos reservados.

Criado pela DJI. Impresso na China.

Дрон

О DJI™ MAVIC™ 2 Enterprise possui Sistemas de Visão Omnidirecionais e Sistemas de Detecção de Infravermelho*, acompanhando uma câmera totalmente estável com estabilizador triaxial, lente de zoom ótico de 2x equivalente a 24-48 mm para gravação de vídeos em 4K e para tirar fotos de 12 megapixels compatíveis com zoom até 6x em FHD. Такие фирменные технологии DJI как система обнаружения препятствий и расширенный автопилот (APAS) упрощают съемку сложных сцен. Дополнительные функции, например, встроенная система AirSense, позволяют анализировать зону полета. Защита паролем обеспечивает безопасность доступа к летательному аппарату и данным. С Mavic 2 Enterprise также можно использовать дополнительные аксессуары: M2E Проектор, M2E Сигнальный огонь и M2E Динамик. Максимальная скорость полета Mavic 2 Enterprise составляет 72 км/ч (44,7 мили/ч), а максимальное время полета** — 31 минута.

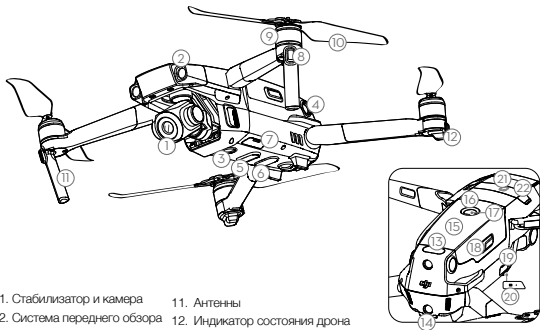

- | | |
|---|--|
| 1. Стабилизатор и камера | 11. Антенны |
| 2. Система переднего обзора | 12. Индикатор состояния дрона |
| 3. Система нижнего обзора | 13. Система верхних инфракрасных датчиков |
| 4. Система бокового обзора | 14. Система заднего обзора |
| 5. Система нижних инфракрасных датчиков | 15. Аккумулятор Intelligent Flight Battery |
| 6. Luz inferior auxiliar. | 16. Светодиодные индикаторы уровня заряда аккумулятора |
| 7. Слот для карты памяти microSD | 17. Кнопка питания |
| 8. Передние огни | 18. Зажимы крепления аккумулятора |
| 9. Электродвигатели | 19. Порт USB-C |
| 10. Пропеллеры | 20. Кнопка подключения/индикатор состояния подключения |
| | 21. Удлиненный порт (для подключения аксессуаров) |
| | 22. Удлиненная крышка для порта |

* Работа систем обзора и систем инфракрасных датчиков зависит от условий окружающей среды. Для получения более подробной информации ознакомьтесь с заявлением об отказе от ответственности и руководством по технике безопасности, руководством пользователя и посмотрите обучающие видео на официальном сайте DJI. <http://www.dji.com/mavic-2-enterprise>

** Результат, полученный во время испытаний при полете в безветренных условиях с постоянной скоростью 25 км/ч (15,5 мили/ч). Данное значение приведено исключительно в справочных целях.

Пульт дистанционного управления

В пульт дистанционного управления встроена технология DJI OCUSSYNC™ 2.0 для передачи данных на большие расстояния, обеспечивающая максимальное расстояние передачи сигнала 8 км (5 миль), а также передачу видео с дрона в приложение DJI Pilot на мобильном устройстве с разрешением до 1080p. Встроенный ЖК-экран передает данные дрона в режиме реального времени, а съемные джойстики упрощают хранение пульта дистанционного управления. Максимальное время работы: 2 часа и 15 минут*



В сложенном состоянии

1. ЖК-экран
2. Кнопка остановки режима полета
3. Кнопка 5D
4. Съемные джойстики
5. Кнопка питания
6. Антенны
7. Кнопка «возврата домой»
8. Слот для хранения джойстиков
9. Резервный порт для передачи видеоданных (USB)
10. Зажим мобильного устройства
11. Переключатель режимов полета

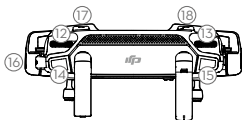
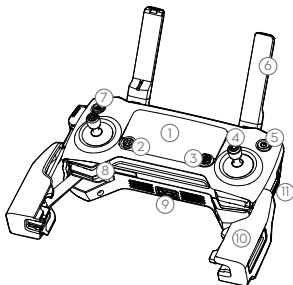

12. Колесико наклона камеры
13. Колесико настройки масштаба
14. Кнопка записи
15. Кнопка экспозамера/спуска затвора
16. Порт передачи видеоданных/разъем питания (micro USB)
17. Кнопка C1 (настраиваемая)
18. Кнопка C2 (настраиваемая)

* Пульт дистанционного управления может работать на максимальном расстоянии передачи сигнала (FCC) на открытом пространстве без электромагнитных помех при высоте полета около 120 м (400 футов). Максимальное время работы измерено в лабораторных условиях. Данное значение приведено исключительно в справочных целях.

1. Загрузите приложение DJI Pilot и посмотрите обучающие видеоролики

Найдите приложение «DJI Pilot» в App Store или Google Play либо отсканируйте QR-код, расположенный ниже, чтобы загрузить приложение на свое мобильное устройство.



DJI Pilot

Обучающие видео на сайте: www.dji.com/mavic-2-enterprise.



Обучающие видеоролики



DJI Pilot поддерживает iOS 10.0 (или более позднюю версию) и Android 4.4.0 (или более позднюю версию).

2. Подготовка дрона

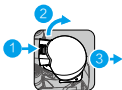

Снимите чехол стабилизатора с камеры.



Разложите передние камеры.



Разложите задние лучи.

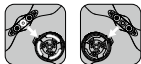

С маркировкой Без маркировки

Соблюдайте цветовую кодировку пропеллеров и электродвигателей.



Надавите на пропеллер и поворачивайте в направлении блокировки.



Разложенное состояние



Всегда раскладываете сначала передние лучи, затем — задние. Все лучи и пропеллеры должны находиться в разложенном состоянии перед взлетом.

3. Зарядка аккумуляторов

Используйте предоставленное в комплекте зарядное устройство, чтобы полностью зарядить аккумулятор Intelligent Flight Battery перед первым использованием.

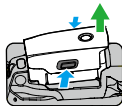

Снимите аккумулятор Intelligent Flight Battery



Время зарядки:
~1 час 30 минут

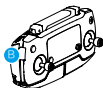

Время зарядки:
~2 часа 15 минут



Снимите кабель пульта дистанционного управления перед зарядкой.

* Проверьте уровень заряда аккумуляторов и включите/выключите питание

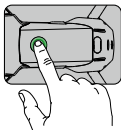

Нажмите один раз для проверки уровня заряда аккумулятора.
Нажмите один раз, затем нажмите и удерживайте для включения/выключения.

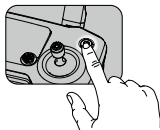

BAT 100 PCT

Нажмите один раз для проверки уровня заряда аккумулятора на ЖК-экране.
Нажмите один раз, затем нажмите и удерживайте для включения/выключения пульта дистанционного управления.



Установите аккумулятор в летательный аппарат и включите его. Если температура аккумулятора опустится ниже +6°C, он начнет нагреваться до достижения температуры +8...+10°C. Подробности см. в руководстве пользователя.

4. Подготовка пульта дистанционного управления к работе

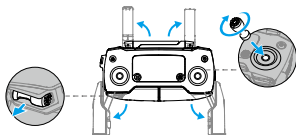

Разверните антенны, зажмите мобильное устройство и установите джойстики.



Подсоедините один конец кабеля пульта дистанционного управления к разъему.

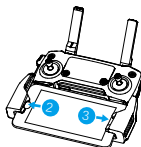

Установите антенны параллельно друг другу

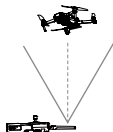
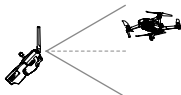

Оптимальный диапазон передачи сигнала

Закрепите ваше мобильное устройство с помощью зажимов.



- Убедитесь, что джойстики надежно закреплены.
- Кабель пульта дистанционного управления с разъемом Lightning установлен по умолчанию. Используйте подходящий для вашего мобильного устройства кабель для подключения к пульту дистанционного управления. При работе с iPad или планшетом используйте порт USB на пульте дистанционного управления.
- Не используйте порты Micro USB и USB одновременно для подключения видео.

5. Подготовка к взлету



Включите пульт дистанционного управления



Включите дрон



Запустите DJI Pilot



Интернет

Для активации дрона используйте вашу учетную запись DJI. Для этого потребуется соединение с интернетом.



Установите пароль для дрона в приложении DJI Pilot, чтобы обеспечить защиту доступа данных.

6. Полет

Перед взлетом убедитесь, что в строке состояния дрона в приложении DJI Pilot показано Ready to Go (Полет разрешен).

Ready to Go (GPS)

* Ручной взлет / посадка

Положение джойстиков для включения/выключения электродвигателей



Плавно сдвиньте левый джойстик вверх для взлета



Смещайте левый джойстик вниз (главно), пока дрон не коснется поверхности. Для выключения двигателей удерживайте джойстик в нижнем положении в течение нескольких секунд.



Двигатели можно останавливать во время полета, только если полетный контроллер обнаруживает критическую ошибку.

* Эксплуатация пульта дистанционного управления

Режим 2 является режимом управления по умолчанию. Левый джойстик используется для управления высотой и поворотом дрона, правый — для управления движением вперед, назад, влево и вправо. Колесико стабилизатора управляет наклоном камеры.

Левый джойстик



Вверх



Вниз



Поворот
налево

Поворот
направо

Правый джойстик



Вперед



Назад



Влево



Вправо



- Перед взлетом всегда устанавливайте подходящую высоту для возврата домой. При возврате в исходную точку дрон необходимо направлять с помощью джойстиков.
- Нажмите на кнопку остановки режима полета для аварийного торможения во время полета.

RU

* Аксессуары



M2E Сигнальный огонь



M2E Проектор



M2E Динамик

7. Соблюдайте правила безопасности полетов



Выполняйте полеты на открытых участках



При сильном сигнале спутников



Выполняйте полет только в пределах прямой видимости



Выполняйте полет на высоте ниже 120 м (400 футов)



Следует избегать полетов над или в непосредственной близости от препятствий, скопления людей, высоковольтных линий электропередачи, деревьев и водоемов. ЗАПРЕЩАЕТСЯ выполнять полеты близко от таких источников сильного электромагнитного поля, как линии электропередачи и базовые станции, т. к. они могут влиять на работу встроенного компаса.



ЗАПРЕЩАЕТСЯ использовать дрон в неблагоприятных погодных условиях, таких как дождь, снег, туман и при скорости ветра более 10 м/с или 22 миль/ч.



Не приближайтесь к вращающимся пропеллерам и электродвигателям.



Зоны, запрещенные для полетов

Более подробная информация приведена на веб-сайте: <http://flysafe.dji.com/no-fly>



Для обеспечения своей безопасности и безопасности окружающих важно понимать основные принципы полета. Для получения дополнительной информации обратитесь к отказу от ответственности и руководству по технике безопасности.

Технические характеристики

• Дрон

Масса	905 г
Максимальная скорость	72 км/ч (44,7 мили/ч) в спортивном режиме в безветренную погоду
Максимальная высота полета над уровнем моря	6000 м (19 685 футов)
Диапазон рабочих температур	от -10 до 40 °C (от 14 до 104 °F)
GNSS	GPS + ГЛОНАСС
Рабочая частота	2,4-2,4835 ГГц
Мощность передатчика (ЭИИМ)	2,4 ГГц FCC: ≤26 дБм; CE/MIC: ≤20 дБм; SRRC: ≤20 дБм
Объем внутренней памяти	24 Гбайт

• Стабилизатор

Рабочий диапазон углов вращения	Наклон: от -90° до +30°
---------------------------------	-------------------------

• Камера

Матрица	CMOS размером 1/2,3" дюйм; количество эффективных пикселей: 12 Мп
Объектив	Угол обзора: приблиз. 83° (24 мм), приблиз. 48° (48 мм) эквивалент формата 35 мм: 24-48 мм Диафрагма: f/2,8 (24 мм) - f/3,8 (48 мм) Фокус: от 0,5 м до ∞
Диапазон ISO	Видео: 100-3200 Фото: 100-1600 (режим авто); 100-3200 (ручной режим)
Диапазон выдержки	8-1/8000 с
Максимальный размер изображения	4000×3000
Режимы фотосъемки	Единый снимок Серийная съемка: 3/5/7 кадров Автоматический брекетинг экспозиции (АЕВ): брекетинг кадра 3/5 с шагом 0,7 EV Автоспуск
Разрешение видео	4K Ultra HD: 3840×2160, 24/25/30 кадров/с 2.7K: 2688×1512, 24/25/30/48/50/60 кадров/с FHD: 1920×1080 24/25/30/48/50/60/120 кадров/с
Битрейт видео	100 Мбит/с
Фото	JPEG, DNG (RAW)
Видео	MP4, MOV (MPEG-4 AVC/H.264, HEVC)
Совместимые карты памяти	microSD Максимальный объем: 128 Гбайт (требуется UHS-1, класс скорости 3)

• Пульт дистанционного управления

Рабочая частота	2,4-2,4835 ГГц
Макс. расстояние передачи сигнала (При отсутствии препятствий и помех)	FCC: 8 км (5 миль); CE/MIC: 5 км (3,1 мили); SRCC: 5 км (3,1 мили)
Диапазон рабочих температур	от 0 до 40 °C (от 32 до 104 °F)

Аккумулятор	3950 мАч при 3,83 В
Мощность передатчика (Э/И/ИМ)	2,4 ГГц FCC: ≤26 дБм; CE/MIC: ≤20 дБм; SRRC: ≤20 дБм
Рабочее напряжение	1800 мА при 3,83 В (при зарядке мобильного устройства)
Размер совместимого мобильного устройства	Толщина: 6,5–8,5 мм, макс. длина: 160 мм Поддерживаемые типы портов USB Lightning, Micro USB (Type-B) USB-C
* Зарядное устройство	
Напряжение	17,6±0,1 В
Номинальная мощность	60 Вт
* Аккумулятор Intelligent Flight Battery	
Емкость	3850 мАч
Напряжение	17,6 В (макс.) 15,4 В (стандартн.)
Тип аккумулятора	Литий-полимерный 4S
Емкость	59,29 Вт·ч
Масса	Около 297 г
Диапазон температуры зарядки	от +5 до +40 °C (от 41 до 104 °F)
Максимальная мощность зарядки	80 Вт
Диапазон температур автоматического нагревания	-10°...+6°C
Время автоматического нагревания	500 с (макс.)
Мощность автоматического нагревания	55 Вт (макс.)

Дополнительную информацию можно найти в руководстве пользователя:
www.dji.com/mavic-2-enterprise

※ Эта отметка означает, что содержание может быть изменено без предварительного уведомления.

MAVIC является товарным знаком компании DJI.

© 2018 DJI Все права защищены.

Разработано DJI. Напечатано в Китае.

MAVIC 2 ENTERPRISE



For online support,
please scan this code with
Facebook Messenger



微信扫一扫
获取技术支持



276DMERM01SE

保密文件，授权接触，违者追责

物料编码	用料	工艺	装订	P数	尺寸	受控日期	设计师
YC.BZ.SS000780.01	道林纸 100g 内文 80 克	单黑	胶装	132	85*115 mm	2018.09.20	10001387
变更内容							

收货标准（包括但不限于）

1. 内容按图纸，文件名料号、封底料号、标签料号需全部一致
2. 包材干净无损不受潮
3. 印刷清晰、颜色均匀、无重影
4. 裁切尺寸准确，不能裁切到文字
5. 装订页码顺序正确，无错页、无漏页、无倒页，表面平整无折皱
6. 骑钉无损不生锈
7. 胶装装订整齐不开胶，不漏胶，胶水环保无异味

此页非印刷页 印刷前请删除

封面水印 confidential，印刷前请删除